



GigaVUE-HC2 Hardware Installation Guide

GigaVUE H Series

Product Version: 6.0

Document Version: 1.0

(See Change Notes for document updates.)

Copyright 2022 Gigamon Inc.. All rights reserved.

Information in this document is subject to change without notice. The software described in this document is furnished under a license agreement or nondisclosure agreement. No part of this publication may be reproduced, transcribed, translated into any language, stored in a retrieval system, or transmitted in any form or any means without the written permission of Gigamon Inc..

Trademark Attributions

Gigamon and the Gigamon logo are trademarks of Gigamon in the United States and/or other countries. Gigamon trademarks can be found at www.gigamon.com/legal-trademarks. All other trademarks are the trademarks of their respective owners.

Gigamon Inc.
3300 Olcott Street
Santa Clara, CA 95054
408.831.4000

Change Notes

When a document is updated, the document version number on the cover page will indicate a new version and will provide a link to this Change Notes table, which will describe the updates.

Product Version	Document Version	Date Updated	Change Notes
6.0	1.0	08/31/2022	Original release of this document with 6.0 GA.

Contents

GigaVUE-HC2 Hardware Installation Guide	1
Change Notes	3
Contents	4
About the GigaVUE H Series and TA Series	8
Introducing the GigaVUE-HC2	9
GigaVUE-HC2 Overview	9
Introducing the GigaVUE-HC2 Chassis	10
Air Flow Direction	12
AC- and DC-Powered GigaVUE-HC2	12
Breakout Panels	12
GigaVUE-HC2 Control Cards	12
GigaVUE-HC2 Control Card Version 2 (HC2 CCv2)	13
GigaVUE-HC2 Modules	14
Module Numbering	15
PRT-HC0-X24 Module	15
PRT-HC0-Q06 Module	16
PRT-HC0-C02 Module	17
GigaTAP Modules	21
TAP-HC0-D25AC0 Module	21
TAP-HC0-D25BC0 Module	21
TAP-HC0-D35CC0 Module	22
TAP-HC0-G100C0 Module	22
Bypass Combo Modules	23
GigaSMART Rear Module	29
GigaSMART Front Module	30
GigaVUE-HC2 Installation Roadmap	33
First Steps – Getting Unpacked, Racked, Installed and Connected	33
Next Steps	34
Assembling the GigaVUE-HC2 Node	35
Unpacking the GigaVUE-HC2 Shipment	35
Rack-Mounting the GigaVUE-HC2 Chassis	36
Safety Precautions	36
Rack-Mounting Procedure	36
Four-Post Rack Mounting	37

Installing Power Modules in the GigaVUE-HC2 Chassis	38
Installing the Cable Management Trays in the GigaVUE-HC2 Chassis	39
Installing Control Card in the GigaVUE-HC2 Chassis	41
Avoid Electrostatic Damage!	42
Control Card Installation Procedure	42
Installing the Rear GigaSMART Module	43
Removing the Rear GigaSMART Module	44
Backing Up Running Configuration	44
Removing the Front GigaSMART Module	45
Installing and Removing Modules Procedure	46
Hot Swapping Modules	46
Module Installation Procedure	46
Module Removal and Replacement Procedure (Hot Removal)	47
Replacing a Module with the Same Type of Module	48
Replacing a Module with a Different Type of Module	48
Next Steps	48
Basic GigaVUE H Series Connections and Configuration	49
Grounding the GigaVUE-HC2 Chassis	49
Connecting Power to the GigaVUE-HC2	50
Removing a Power Module	51
Connecting -48V DC Power Supplies	52
Fan Trays	53
Checking Fan Status	53
Configuring SNMP Notification	53
Replacing a Fan Tray	53
Connecting Serial Console and Mgmt Ports	54
Configuring Basic GigaVUE H Series H Series Settings	54
Access the Command-Line Interface over the Console Port	55
Run the Jump-Start Script	56
Configure Modules and Enable Ports	58
Command-Line Basics	60
Command-Line Modes	60
Entering Commands in the CLI	61
Command-Line Syntax – Entering Commands	63
The Basic Commands	64
Completing the Initial GigaVUE H Series H Series Setup	68
Enter the Configure Command-Line Mode	69
SSH2	69
Initial User Account Configuration	70
Configuring the GigaVUE H Series H Series Host Name	72
Configuring GigaVUE H Series H Series Time Options	72
Configuring Automatic Email Notifications	74

Using a Custom Banner	75
Saving Changes	76
Connecting GigaVUE-HC2 Ports	77
Transceiver—Rules and Notes	77
BiDi Optics Considerations	77
Transceiver Installation Instructions	78
Installing Transceivers	78
Removing Transceivers	78
Fiber TAP Specifications	79
Bypass Combo Module Specifications	79
Module Transceiver Support	80
Cabling	81
MPO/MTP 12 Position Fiber Cable for Use with SR4 Transceivers	81
Connecting GigaVUE-HC2 Module Ports	81
Enabling Modules and Ports	81
Setting Port Parameters Manually	83
GigaVUE-HC2 Specifications	86
Physical Dimensions and Weight	86
Battery Caution	87
Power Requirements	87
Environmental Specifications	87
Standards and Protocols	88
Compliance	88
Emissions	88
Class A Information Technology Equipment (ITE)	88
Emissions	93
Warranty	93
Replacing a Control Card	94
Upgrading to HC2 CCv2	103
Standalone Node	103
Node in Out-of-Band Cluster	106
Node in Inband Cluster	107
Console Port Signaling and Cabling	110
NEBS Level 3 Compliance	112
Installation Instructions GigaVUE-HC2	112
Intrabuilding or Intra-connection	112
Intrabuilding Ports (RJ45)	113
Class A2 Voltage Accessibility	113
Class B Voltage Accessibility	113
Equipment Grounding Systems	113

Communication Equipment Grounding	113
Bonding of Battery Return (BR) Input Terminals	113
Connections	113
Input AC/DC Voltage	114
Commercial Power Ports	114
Maintenance	114
Additional Sources of Information	115
Documentation	115
How to Download Software and Release Notes from My Gigamon	117
Documentation Feedback	118
Contact Technical Support	119
Contact Sales	119
Premium Support	120
The Gigamon Community	120
Glossary	121

About the GigaVUE H Series and TA Series

The Gigamon Visibility and Analytics Fabric delivers 1Gb/10Gb/40Gb/100Gb support. The GigaVUE H Series and TA Series include the following models that run GigaVUE-OS:

- GigaVUE-HC1
- GigaVUE-HC2
- GigaVUE-HC3
- GigaVUE H Series-TA10
- GigaVUE H Series-TA40
- GigaVUE H Series-TA100
- GigaVUE H Series-TA100-CXP
- GigaVUE H Series-TA200
- Certified Traffic Aggregation White Boxes

Introducing the GigaVUE-HC2

This chapter introduces the GigaVUE-HC2 of Gigamon Traffic Platform nodes, describes their features and functions, and provides an orientation to the physical layout of the GigaVUE-HC2.

Refer to the following sections for details:

- [About the GigaVUE H Series and TA Series](#)
- [GigaVUE-HC2 Overview](#)
- [Introducing the GigaVUE-HC2 Chassis](#)
- [GigaVUE-HC2 Control Cards](#)
- [AC- and DC-Powered GigaVUE-HC2](#)
- [GigaVUE-HC2 Modules](#)
 - [Module Numbering](#)
 - [PRT-HC0-X24 Module](#)
 - [PRT-HC0-Q06 Module](#)
 - [PRT-HC0-C02 Module](#)
 - [GigaTAP Modules](#)
 - [TAP-HC0-D25AC0 Module](#)
 - [TAP-HC0-D25BC0 Module](#)
 - [TAP-HC0-D35CC0 Module](#)
 - [TAP-HC0-G100C0 Module](#)
 - [Bypass Combo Modules](#)
 - [10Gb Bypass Combo Modules](#)
 - [40Gb Bypass Combo Module](#)
 - [GigaSMART Rear Module](#)
 - [GigaSMART Front Module](#)

GigaVUE-HC2 Overview

The GigaVUE-HC2 delivers unprecedented switching capacity, port density, and modularity in a mid-sized 2RU footprint. This node broadens the GigaVUE H Series H Series portfolio offering multi-functional capabilities such as internal TAPs, port modules, and a variety of GigaSMART options. The node is appropriate for concentration points requiring up to 96 ports in a single location.

GigaVUE-HC2 Chassis – Rear View

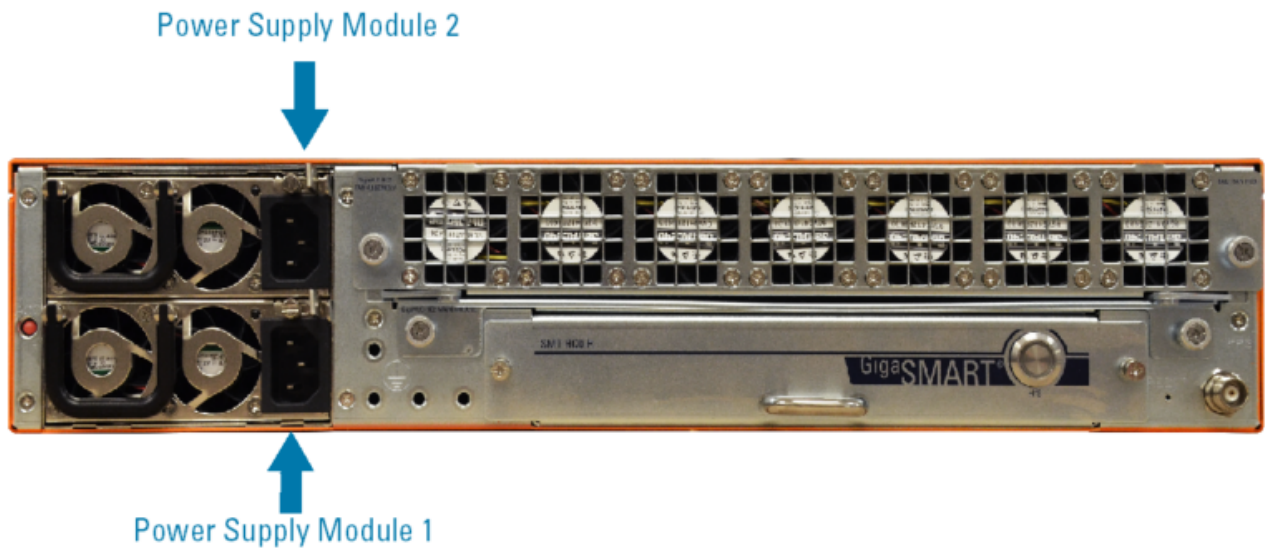

Figure 2 Rear View of the GigaVUE-HC2 Chassis

Table 1: GigaVUE-HC2 Chassis Bays and Components

Bays on the GigaVUE-HC2 Chassis	
Module Bays	There are four module bays. They are numbered from 1 to 4, starting with top left, then bottom left; top right, then bottom right.
Cable Management Tray	The GigaVUE-HC2 provides two optional cable management trays at the left and right side of the node for secure routing of cables to GigaVUE H Series ports. Installation of the cable management tray requires a special mounting bracket. Refer to Rack-Mounting Procedure for details.
Rear Components on the GigaVUE-HC2 Chassis	
Power Modules	<p>The GigaVUE-HC2 includes two separate power supplies for installation at the rear of the node. Each power module can independently operate the entire GigaVUE-HC2 for 1+1 system redundancy. Separate AC and DC power units are available.</p> <p>Refer to Power Requirements for information on power characteristics of the GigaVUE-HC2.</p>
Control Card	<p>The GigaVUE-HC2 includes a control card installed inside the unit, accessible from the rear of the chassis, behind the fan unit.</p> <p>The control card provides switching and processing resources for the entire chassis. It also controls the Mgmt port and console port on the front of the node for network and local administrative access to the GigaVUE-OS command-line interface (CLI).</p> <p>Starting in software version 4.6, GigaVUE-HC2 Control Card version 2 (HC2 CCv2) is available.</p> <p>Refer to GigaVUE-HC2 Control Cards for more information.</p>
Fan Trays	The fan trays installed at the rear of the node provide system cooling.

Air Flow Direction

The air flow direction is from the front of the GigaVUE H Series chassis to the rear. The rear-mounted fans pull air from the front to the back of the chassis. For environments with hot/cold aisles, install the chassis so the intake air at the front of the chassis is cold.

AC- and DC-Powered GigaVUE-HC2

Gigamon provides both AC- and DC-powered versions of the GigaVUE-HC2. Both models support the same control modules and can be populated with the modules of your choice. Refer to [Installing Power Modules in the GigaVUE-HC2 Chassis](#) for information on connecting DC power supplies.

Breakout Panels

Breakout panels let you connect ports on a GigaVUE H Series node to a tool or network port or TAP for port breakout or aggregation.

The following breakout panels are available:

- PNL-M341/PNL-M341T
- PNL-M343/PNL-M343T

Refer to *G-TAP M Series Hardware Guide* for details.

GigaVUE-HC2 Control Cards

The control card is the heart of the GigaVUE-HC2, providing both processing and switching fabric resources, as well as user access to the CLI via the Mgmt/console ports.

Starting in software version 4.6, GigaVUE-HC2 Control Card version 2 (HC2 CCv2) is available.

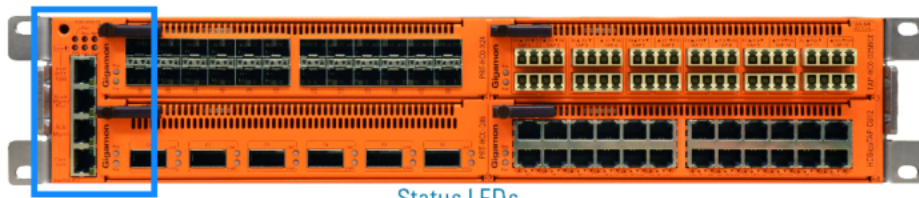

Status LEDs

Shows the status of the control module, including whether the module has power (PWR), whether the module is successfully booted and ready for operations (RDY)

- PWR - Illuminates when power is present.
- RDY - Module booted and ready for operations
- M/S - Master/Slave: Illuminated when it is a master in a cluster; it is off when it is a normal or standby node in a cluster; it is either off or illuminated when it is a standalone node, depending on whether or not it was ever the master node in a cluster previously
- Fan - Illuminated when fans are operating
- Rear - Illuminated when rear GigaSMART is ready

PTP Port (eth1)

Connection for PTP grandmaster clock source. After configuring an IP profile for the PTP port, you can enable PTP in the CLI with the "ptp enable" command. Refer to the *GigaVUE-OS CLI Reference Guide* for details.

Cluster Management Port (eth2)

Provides cluster support, with a dedicated out-of-band network connection for cluster management traffic.

Management Port (eth0)

Standard 10/100/1000 RJ45 Ethernet port supports remote connections to the GigaVUE-OS using Telnet/SSH. Green LED shows link status; amber LED shows activity.

Console Port

Use the console port for serial terminal connections to the GigaVUE-OS. Unless you requested custom factory settings, the serial settings are 8N1, 115,200 bps. The GigaVUE-HC2 node includes a standard console cable.



Lock Status LEDs

Illuminates when the node has synchronized successfully with the corresponding time source:

- PPS (In) -- Illuminates when the node has synchronized with a pulse-per-second source over the PPS input selected with the "timestamp pps-source" command

Figure 3 GigaVUE-HC2 Management Ports

GigaVUE-HC2 Control Card Version 2 (HC2 CCv2)

GigaVUE-HC2 Control Card version 2 (HC2 CCv2) provides the following benefits:

- Enables 100Gb on the PRT-HC0-C02 module. Refer to [PRT-HC0-C02 Module](#).
- Supports 16k map rules.
- Supports all GigaVUE-HC2 modules, front and rear.
- Has the same ports and status LEDs as shown in [Figure 3 GigaVUE-HC2 Management Ports](#).
- Supports SMT-HC0-Q02X08 module. Refer to [GigaSMART Front Module](#)

HC2 CCv2 is field-replaceable. To upgrade an existing control card to an HC2 CCv2, use the procedure in [Standalone Node](#).

The HC2 CCv2 is identified by the following part number label printed on the control card: 132-00C2-400.

NOTE: The software version on the HC2 CCv2 must be 4.6 or higher.

GigaVUE-HC2 Modules

With a wide variety of interchangeable modules and more than a terabit of switching capacity, GigaVUE-HC2 nodes are ready to grow with your needs. Separate modules let you add the ports you need:

PRT-HC0-X24	<ul style="list-style-type: none"> ▪ Twenty-four 10Gb/1Gb (SFP+, SFP+ Copper/SFP) Ports 	PRT-HC0-X24 Module
PRT-HC0-Q06	<ul style="list-style-type: none"> ▪ Six 40Gb (QSFP+) Ports 	PRT-HC0-Q06 Module
PRT-HC0-C02	<ul style="list-style-type: none"> ▪ Two 100Gb (QSFP28) Ports 	PRT-HC0-C02 Module
TAP-HC0-D25AC0	<ul style="list-style-type: none"> ▪ Twelve TAP SX/SR (50/125) Fiber TAP 	TAP-HC0-D25AC0 Module
TAP-HC0-D25BC0	<ul style="list-style-type: none"> ▪ Twelve TAP SX/SR (62.5/125) Fiber TAP 	TAP-HC0-D25BC0 Module
TAP-HC0-D35CC0	<ul style="list-style-type: none"> ▪ Twelve TAP LX/LR Fiber TAP 	TAP-HC0-D35CC0 Module
TAP-HC0-G100C0	<ul style="list-style-type: none"> ▪ Twelve TAP 1Gb Copper TAP 	TAP-HC0-G100C0 Module
BPS-HC0-D25A4G	<ul style="list-style-type: none"> ▪ Bypass Combo Module, GigaVUE-HC2, with Four SX/SR (50/125µm) BPS Port Pairs and Sixteen SFP and SFP+ Port Cages 	10Gb Bypass Combo Modules
BPS-HC0-D25B4G	<ul style="list-style-type: none"> ▪ Bypass Combo Module, GigaVUE-HC2, with Four SX/SR (62.5/125µm) BPS Port Pairs and Sixteen SFP and SFP+ Port Cages 	10Gb Bypass Combo Modules
BPS-HC0-D35C4G	<ul style="list-style-type: none"> ▪ Bypass Combo Module, GigaVUE-HC2, with Four LX/LR BPS Port Pairs and Sixteen SFP and SFP+ Port Cages 	10Gb Bypass Combo Modules
BPS-HC0-Q25A28	<ul style="list-style-type: none"> ▪ Bypass Combo Module, GigaVUE-HC2, with Two SR4 (50/125µm) BPS Port Pairs and Eight SFP and SFP+ Port Cages 	40Gb Bypass Combo Module

SMT-HC0-R	<ul style="list-style-type: none"> GigaSMART Rear Module 	GigaSMART Rear Module
SMT-HC0-X16	<ul style="list-style-type: none"> GigaSMART Front Module with Sixteen 10Gb SFP and SFP+ Port Cages 	GigaSMART Front Module
SMT-HC0-Q02X08	<ul style="list-style-type: none"> GigaSMART Front Module with Two 40Gb ports and Eight 10Gb/1Gb SFP+ and SFP ports. 	GigaSMART Front Module

Modules are hot-swappable and can be installed in any of the available front bays in a GigaVUE-HC2 node. **However, refer to [Module Removal and Replacement Procedure \(Hot Removal\)](#) for instructions – you must follow a specific procedure when removing modules to preserve node stability.**

Module Numbering

Modules use standard conventions for identifying network/tool ports, both on the modules themselves, as well as in the CLI:

100Gb Ports	<ul style="list-style-type: none"> Numbered with a leading C. For example, the PRT-HC0-C02 includes 100Gb ports C1 and C2.
40Gb Ports	<ul style="list-style-type: none"> Numbered with a leading Q. For example, the PRT-HC0-Q06 includes 40Gb ports Q1 to Q6.
10Gb Ports	<ul style="list-style-type: none"> Numbered with a leading X. For example, the PRT-HC0-X24 includes 10Gb/1Gb ports X1 to X24, the bypass combo modules include 10Gb ports X1 to X16.
1Gb Ports	<ul style="list-style-type: none"> Numbered with a leading G.

NOTE: When referring to ports in the CLI, the format is **box ID/slot ID/port ID**. For example, **1/1/x6** refers to box 1, slot 1, port X6.

- GigaVUE-HC2:** Slots (bays) are numbered 1-4 from left upper, left lower, right upper to right lower.

NOTE: The port labels on the module faceplate use upper-case C, Q, X, and G characters to identify ports. However, the CLI uses lowercase notation to refer to ports (for example, c1, q1, x1, and g1).

PRT-HC0-X24 Module

The PRT-HC0-X24 module provides a total 240Gb of connectivity with line rate on-board switching across twenty-four 10Gb SFP+ ports. All ports in the PRT-HC0-X24 module can be used as network, tool, inline tool, or stack-link ports.

For details about the supported transceiver, cable type, fanout, inline ports, and clusters, refer to “GigaVUE-OS Compatibility and Interoperability Matrix”.

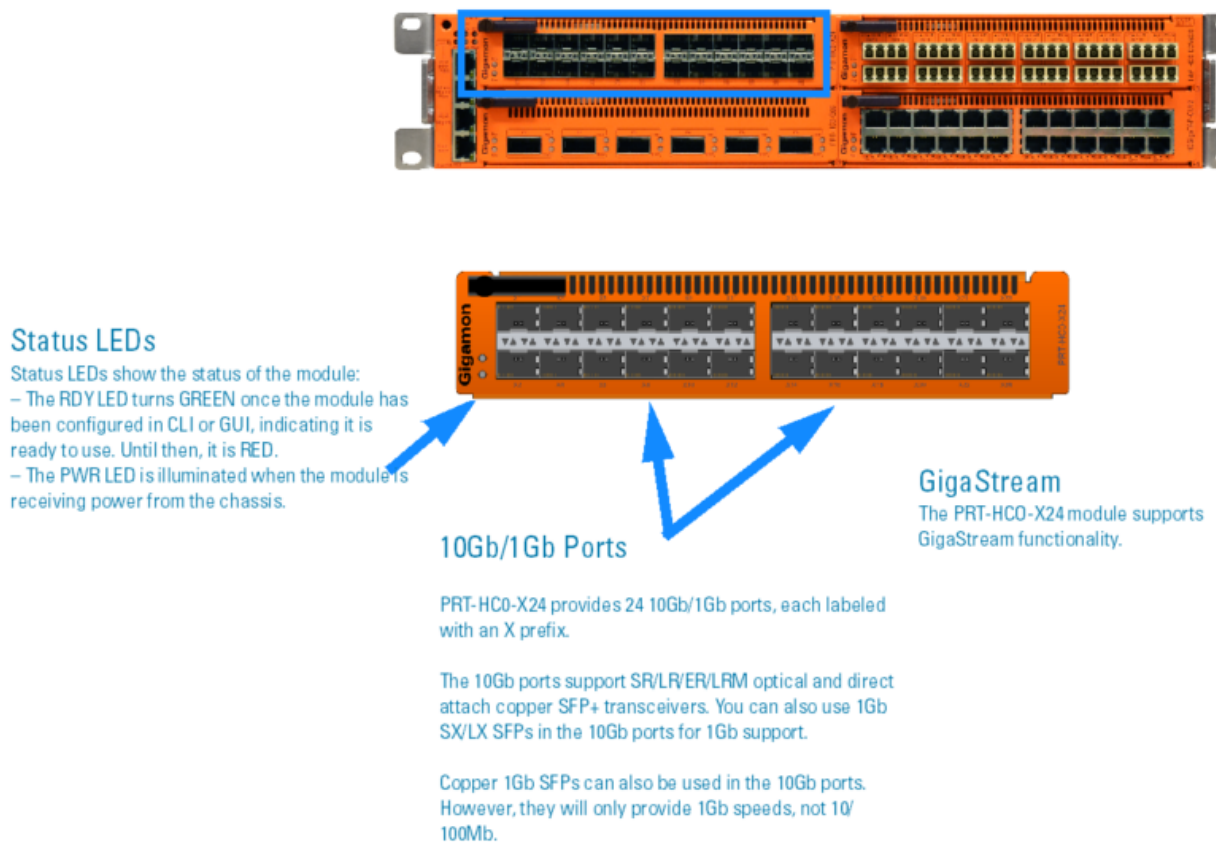

Figure 4 PRT-HC0-X24 Module

PRT-HC0-Q06 Module

The PRT-HC0-Q06 module provides a total 240Gb of connectivity with line-rate on-board switching across six 40Gb QSFP+ ports. All ports in the PRT-HC0-Q06 module can be used as network, tool, inline tool, or stack-link ports. In particular, 40Gb ports are useful as stack-links to carry traffic between GigaVUE H Series nodes operating in a cluster or to receive aggregated input from a matching 40Gb port on a GigaVUE H Series TA Series aggregation node. The PRT-HC0-Q06 module can connect to all GigaVUE H Series nodes that support 40Gb through a 40Gb stack-link, using SR4, ESR4, and LR4 optics. However, you cannot connect this module with PRT-HC0-C02 on GigaVUE-HC2.

For details about the supported transceiver, cable type, fanout, inline ports, and clusters, refer to “GigaVUE-OS Compatibility and Interoperability Matrix”.

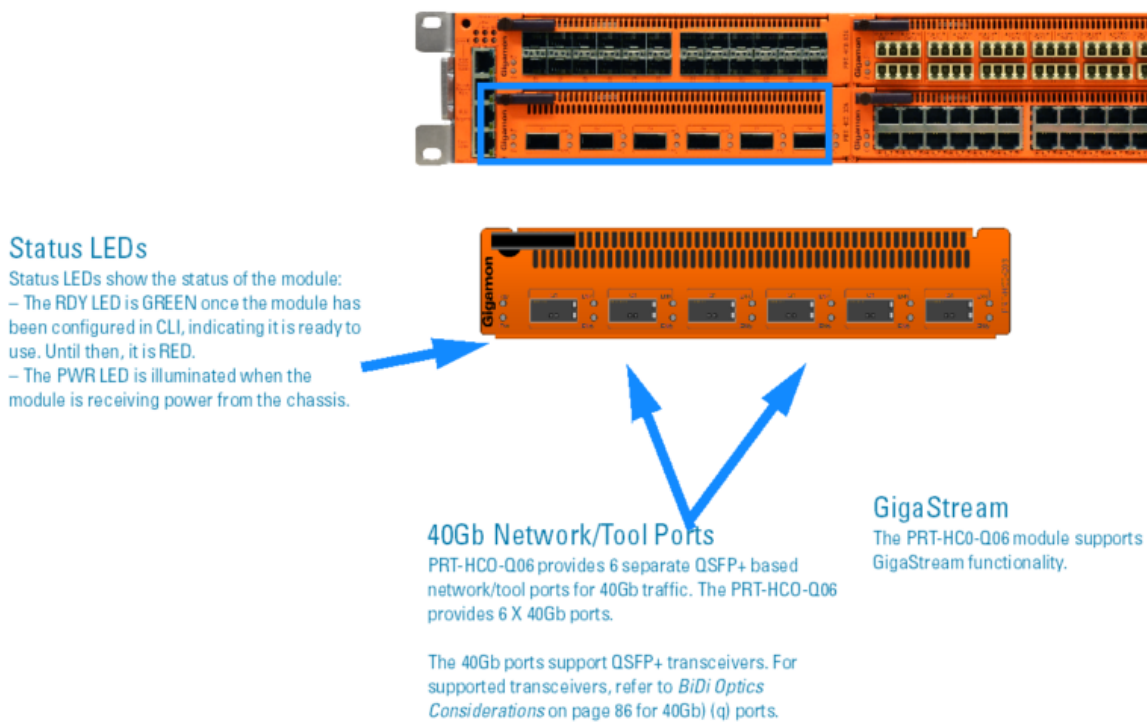

Figure 5 PRT-HC0-Q06 Module

PRT-HC0-C02 Module

The PRT-HC0-C02 module provides two 100Gb QSFP28 ports, supporting 100Gb monitoring and aggregation.

The PRT-HC0-C02 is installed in the front module bays of the GigaVUE-HC2.

Before installing the PRT-HC0-C02 module, the GigaVUE-HC2 node must be running software version 4.6 or higher.

For details about the supported transceiver, cable type, fanout, inline ports, and clusters, refer to “GigaVUE-OS Compatibility and Interoperability Matrix”.

NOTE: The PRT-HC0-C02 can only be used on a GigaVUE-HC2 node equipped with GigaVUE-HC2 Control Card version 2 (HC2 CCv2). Refer to [Figure 6 PRT-HC0-C02 Front Module](#).

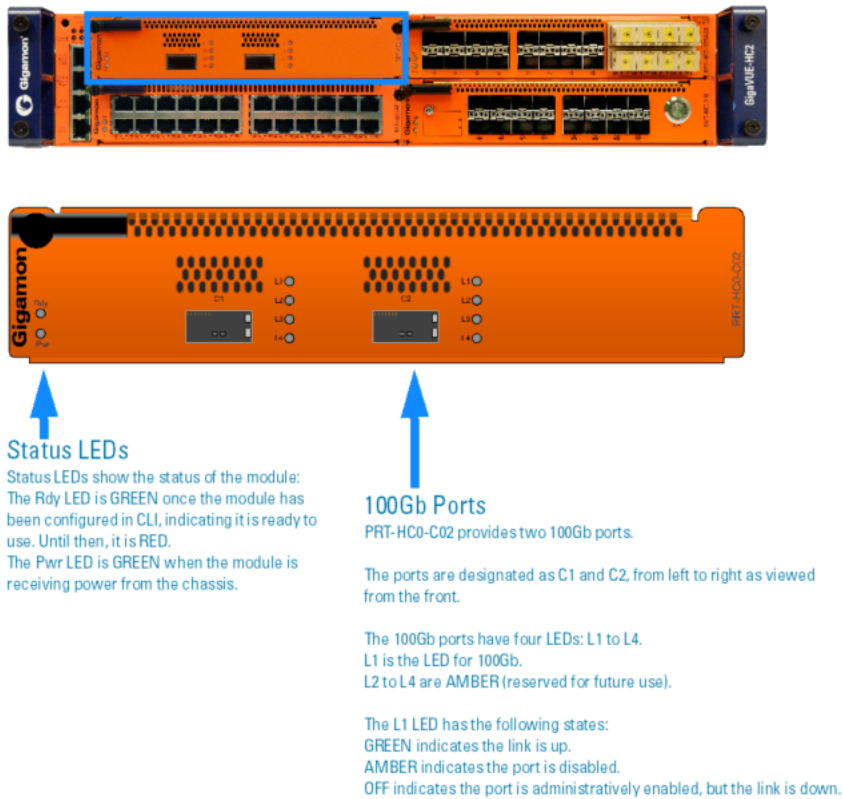

Figure 6 PRT-HC0-C02 Front Module

Module Status LEDs

The module status LEDs are as follows:

- Rdy is the Ready LED. It has the following states:
 - RED indicates the system is booting up
 - GREEN indicates the system is ready
- Pwr is the Power LED. It has the following state:
 - GREEN indicates the module is receiving power

Port Status LEDs

The 100Gb port status LED, L1, has the following states:

- Off indicates the port is administratively enabled, but the link is operationally down
- GREEN indicates the link is operationally up
- AMBER indicates the port is disabled

The 100Gb port status LEDs, L2 to L4, have the following state:

- AMBER indicates reserved for future use

PRT-HC0-C02 Notes and Rules

Keep in mind the following notes and rules when using the PRT-HC0-C02 module:

PRT-HC0-C02 Notes	
Control Card Version 2 Required	The PRT-HC0-C02 can only be used on a GigaVUE-HC2 node equipped with GigaVUE-HC2 Control Card version 2 (HC2 CCv2).
Transceivers	For details about the supported transceiver, cable type, and connectivity specifications, refer to <i>"GigaVUE-OS Compatibility and Interoperability Matrix"</i> .
Maximum PRT-HC0-C02 Modules Per Chassis	<p>The maximum number of PRT-HC0-C02 modules per chassis is four, supporting up to eight 100Gb ports.</p> <div style="border: 1px solid #ccc; padding: 5px; margin: 5px 0;"> <p>NOTE: If all modules in the chassis are 100Gb, there are no 10Gb ports with which to connect tools.</p> </div> <p>Refer also to 100G Chassis Mode for PRT-HC0-C02 and Module Placement of PRT-HC0-C02.</p>
Network, Tool, Hybrid, or Stack-Link Port	The 100Gb ports on the PRT-HC0-C02 can be used as a network, tool, or hybrid ports. They cannot be used as stack-link ports.
Inline Ports	<p>The 100Gb ports can be configured as inline network or inline tool ports, supporting 100Gb logical bypass.</p> <p>For details about the supported inline ports, refer to <i>"GigaVUE-OS Compatibility and Interoperability Matrix"</i>.</p>
Map Rules	The PRT-HC0-C02 supports 16k (16383) map rules per module. The maximum number of rules per map is 4k (4096).

100G Chassis Mode for PRT-HC0-C02

GigaVUE-HC2 nodes equipped with Control Card version 2 (HC2 CCv2) AND 100Gb modules, PRT-HC0-CO2, require a chassis mode of **100G** to be configured in software.

The platform PRT-HC0-CO2 has two modes **default** and **100G**. The platform will be in **default** mode. To change the mode to **100G**, first remove the existing configuration from the chassis, then configure the mode. For example:

```
(config) # no chassis box-id 1
(config) # chassis box-id 1 mode 100G| [left|right]
```

To switch to default mode, configure as follows:

```
(config) # no chassis box-id 1
(config) # chassis box-id 1 mode default
```

When the GigaVUE-HC2 has a PRT-HC0-CO2 module installed and the mode is configured to **100G**, the port count is limited to 42 ports on the columns of the node. Modules in bays 1 and 2 are the left column, and modules in bays 3 and 4 are the right column. Refer to [Figure 1 Front View of the GigaVUE-HC2 Chassis](#) for a view of the front of the chassis. Also, refer to [Module Placement of PRT-HC0-C02](#) for best practices when **100G** mode is configured.

Starting in software version 4.7.01, you can optionally specify the **100G** mode on either the left column or the right column of the node. For example:

```
(config) # chassis box-id 1 mode 100G left
```

When the left column is configured for **100G** mode, install the PRT-HC0-CO2 module in the bays in the left column. The left column is subject to the 42 port limitation. The right column will not be limited to 42 ports, but you will not be able to install the PRT-HC0-CO2 module in the bays in the right column.

Conversely, when the right column is configured for **100G** mode, install the PRT-HC0-CO2 module in the bays in the right column. The right column is subject to the 42 port limitation. The left column will not be limited to 42 ports, but you will not be able to install the PRT-HC0-CO2 module in the bays in the left column.

Module Placement of PRT-HC0-CO2

With 42 ports per column, the best practices for placement of PRT-HC0-CO2 modules are as follows:

- Place PRT-HC0-CO2 modules in bays 1 and 3 or bays 2 and 4. This uses 2 ports on each column, leaving 40 ports for the other module in the column.
- Use only one 24-port module per column. The 24-port modules are: PRT-HC0-X24, Bypass Combo Modules (BPS-HC0-D25A4G, BPS-HC0-D25B4G, BPS-HC0-D35C4G), and TAP modules (TAP-HC0-D25AC0, TAP-HC0-D25BC0, TAP-HC0-D35CC0, TAP-HC0-G100C0).

Refer to [Figure 7](#) **Module Placement of PRT-HC0-CO2, 100G Mode** for examples of incorrect and correct module placement when **100G** mode is configured.



Figure 7 *Module Placement of PRT-HC0-CO2, 100G Mode*

Refer to [Figure 8](#) **Module Placement of PRT-HC0-CO2, 100G Left Mode** for an example of module placement when **100G left** mode is configured.



Figure 8 *Module Placement of PRT-HC0-CO2, 100G Left Mode*

GigaTAP Modules

GigaTAP modules provide internal TAP (Tapping Access Point) capabilities to passively copy optical traffic flowing between two external sources (typically, switches, routers, and servers) into the GigaVUE-HC2 node.

These modules contains 24 fiber ports, set up in pairs to allow bidirectional traffic to continue to flow between the original sources and destinations. Since there are 12 sets of port pairs, the modules provide for 12 TAPs. An internal optical splitter passively copies the traffic to the backplane at line speeds. Even in the event of a power loss in the chassis, traffic will continue to pass between the original source and destination.

Unlike an external TAP, an internal TAP has no external ports for the copied traffic; as the traffic goes directly to the backplane of the unit. This maximizes the use of the ports on the module to provide maximum TAP density. This also prevents unauthorized users from attaching a local Sniffer to capture and see the packets without permission. Thus, only users properly logged into the system gain access to sensitive information.

For internal transceiver and loss summary specifications, refer to [Fiber TAP Specifications](#).

TAP-HC0-D25AC0 Module

The GigaTAP TAP-HC0-D25AC0 module provides 12 SX/SR TAP connections to be used as network ports running over 50/125 micron fiber. This module has 24 ports, enabling 12 TAPs. Each port pair is arranged one above the other providing bidirectional traffic to flow between two nodes. Internally, a splitter passively copies traffic for use with flow maps.

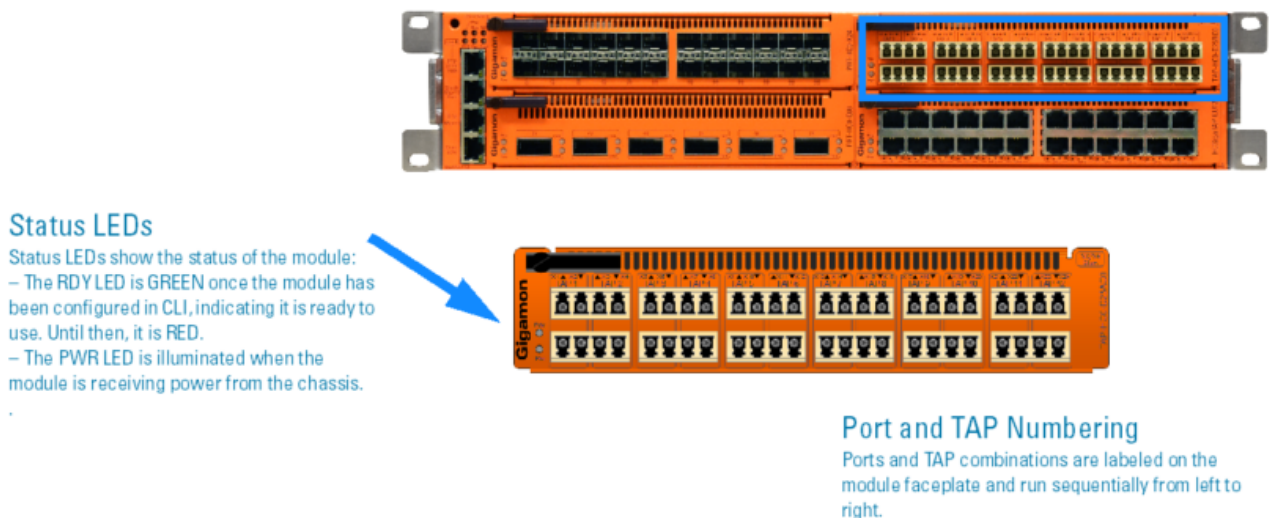

Figure 9 TAP-HC0-D25AC0 Module

TAP-HC0-D25BC0 Module

The GigaTAP TAP-HC0-D25BC0 module provides 12 SX/SR TAP connections to be used as network ports running over 62.5/125 micron fiber. This module has 24 ports, enabling 12 TAPs. Each port pair is arranged one above the other providing bidirectional traffic to flow

between two nodes. Internally, a splitter passively copies traffic for use with flow maps.

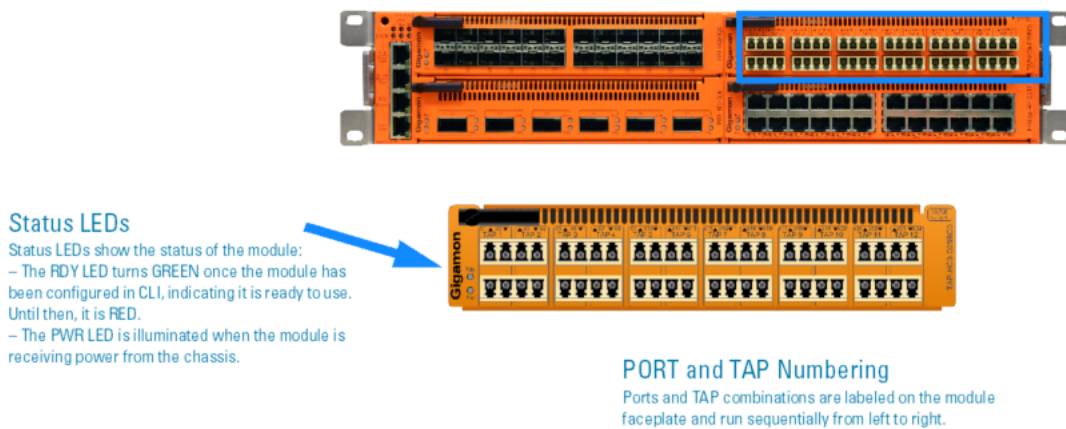

Figure 10 TAP-HC0-D25BC0 Module

TAP-HC0-D35CC0 Module

The GigaTAP TAP-HC0-D35CC0 module provides 12 LX/LR TAP connections to be used as network ports running over singlemode fiber. This module has 24 ports, enabling 12 TAPs. Each port pair is arranged one above the other providing bidirectional traffic to flow between two nodes. Internally, a splitter passively copies traffic for use with flow maps.

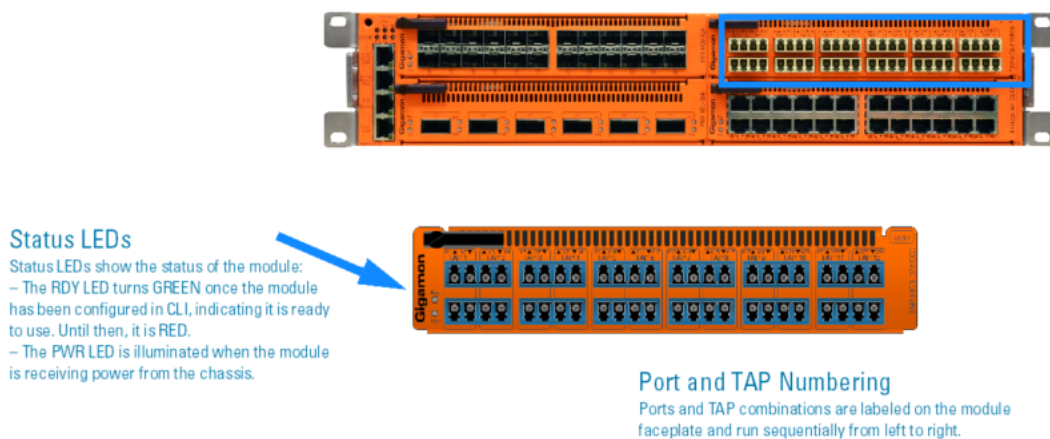

Figure 11 TAP-HC0-D35CC0 Module

TAP-HC0-G100C0 Module

The GigaTAP TAP-HC0-G100C0 module provides 12 1Gb Copper TAP connections to be used as network ports. On GigaVUE-HC2 (control card version 1), the only supported speed is 1Gb. On GigaVUE-HC2 (control card version 2), 10/100Mb speed is also supported. This module has 24 ports, enabling 12 TAPs. Each port pair is arranged with one port above the other, providing bidirectional traffic flow between two nodes. Traffic is copied through the use of a port pair, unless the port pair is in the physical bypass state. Refer to [Figure 12TAP-HC0-G100C0 Module](#).

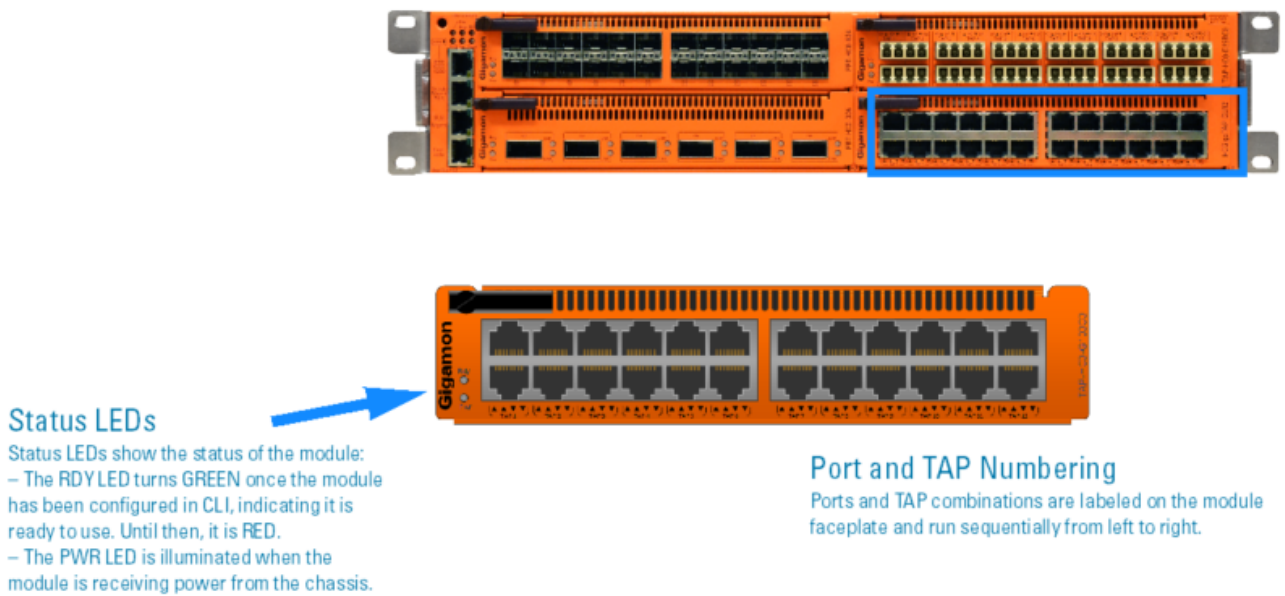

Figure 12 TAP-HC0-G100C0 Module

Using the TAP-HC0-G100C0 Module for Copper Bypass

The network ports on the TAP-HC0-G100C0 module can be configured through software to be inline network ports. This allows the TAP-HC0-G100C0 module to act as a copper bypass module, providing protected inline networks for copper ports.

To use the copper bypass functionality, the GigaVUE-HC2 must be running GigaVUE-OS version 4.3 or higher. For configuration information, refer to the chapter “Configuring Inline Bypass Solution on GigaVUE H Series TAP Modules” in the *GigaVUE-OS CLI Reference Guide*.

Using TAP-HC0-G100C0 Module for Gigamon Resiliency for Inline Protection

Gigamon Resiliency for Inline Protection (GRIP)[™] is an inline bypass solution that connects two GigaVUE-HC2 nodes together so that one node provides high availability to the other node when there is a loss of power. This redundant arrangement of two GigaVUE-HC2 nodes maintains traffic monitoring by inline tools when one of the nodes is down.

GRIP[™] makes use of the bypass protection switch relays for protected inline networks on GigaVUE-HC2 nodes. The TAP-HC0-G100C0 module can provide physical protection for protected pairs of copper inline network ports required by the GRIP solution.

To configure the GRIP solution, the GigaVUE-HC2 must be running GigaVUE-OS version 4.4 or higher. For solution and configuration information, refer to the chapter “Configuring Inline Bypass Solutions” in the *GigaVUE-OS CLI Reference Guide*.

Bypass Combo Modules

Security tools such as firewall and intrusion detection/protection systems are often connected inline on production networks, with traffic flowing from the network segment through the tool and then back onto the production network.

The GigaVUE-HC2 offers physical and logical inline bypass. Physical bypass provides automatic failover protection in the case of a power failure. The bypass combo modules provide the physical bypass function. As it applies to a single pair of inline network ports, the physical bypass function is as follows:

- When the module is not powered, (either the entire node is powered down or the module is removed from the node), the inline network port pair is in the physical bypass mode. That means that traffic is exchanged directly between network Port A and network Port B of the inline network pair.
- When the module is powered, the mode (inline or bypass) of the inline network port pair is controlled through software. In the physical bypass mode, the inline network port pair behaves exactly as if the module was not powered. In the inline mode, the inline network port pair behaves as any other inline network port pair configured for working with an inline tool.

The GigaVUE-HC2 supports the following 10Gb and 40Gb bypass combo modules:

- [10Gb Bypass Combo Modules](#)
- [40Gb Bypass Combo Module](#)

10Gb Bypass Combo Modules

There are three 10Gb bypass combo modules as follows:

- Bypass Combo Module with four SX/SR (50/125µm multimode) inline network port pairs and sixteen regular SFP+ port cages (BPS-HC0-D25A4G) ([Figure 13 Bypass Combo Module BPS-HC0-D25A4G](#))
- Bypass Combo Module with four SX/SR (62.5/125µm multimode) inline network port pairs and sixteen regular SFP+ port cages (BPS-HC0-D25B4G) ([Figure 14 Bypass Combo Module BPS-HC0-D25B4G](#))
- Bypass Combo Module with four LX/LR (singlemode) inline network port pairs and sixteen regular SFP+ port cages (BPS-HC0-D35C4G) ([Figure 15 Bypass Combo Module BPS-HC0-D35C4G](#))

Before installing any of the 10Gb bypass combo modules, the GigaVUE-HC2 must be running software version 4.1 or higher.

For internal transceiver and loss summary specifications, refer to [Bypass Combo Module Specifications](#).

Features of 10Gb Bypass Combo Modules

The 10Gb bypass combo modules have the following features:

- Four inline network port pairs that pass traffic bi-directionally.
- Port pairs that offer optical protection switch for physical bypass.
- Sixteen regular SFP ports that can operate at 1Gb, SFP+, and SFP+ Copper ports that can operate at 10Gb. These ports can be configured as any port type.
- A mode to select either bypass or inline.
- A module that is hot swappable. Refer to procedures in [Module Removal and Replacement Procedure \(Hot Removal\)](#).

GigaBPS Bypass Combo Module in GigaVUE-HC2

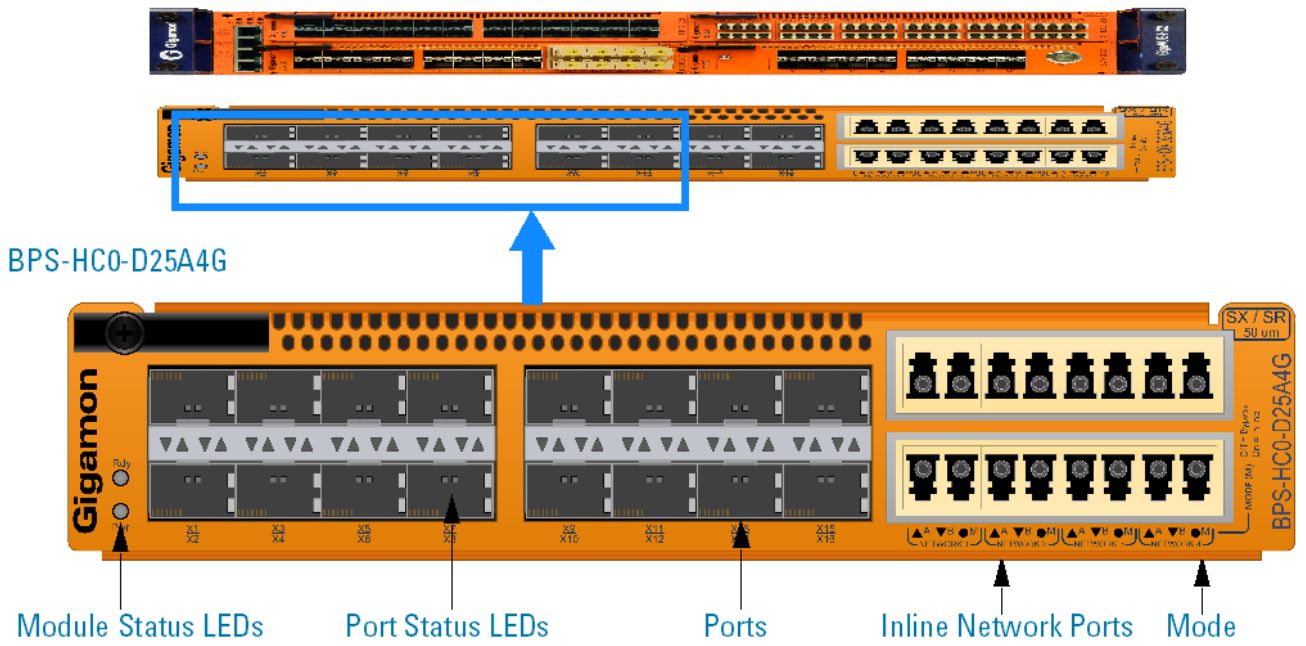

Figure 13 Bypass Combo Module BPS-HC0-D25A4G

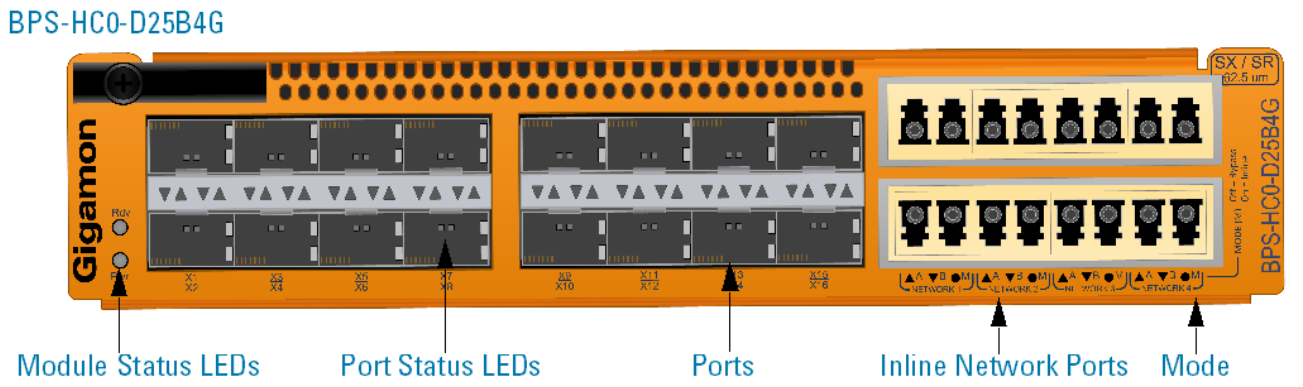

Figure 14 Bypass Combo Module BPS-HC0-D25B4G

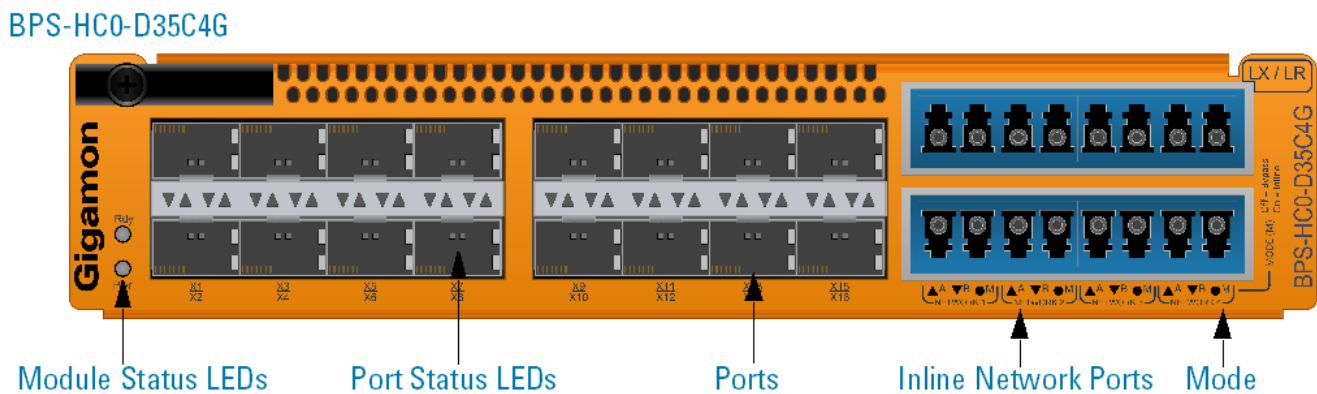

Figure 15 *Bypass Combo Module BPS-HC0-D35C4G***Module Status LEDs**

The following module status LEDs are located on the front of the bypass combo modules:

- Rdy is the Ready LED. It has the following states:
 - RED indicates system booting or module down
 - GREEN indicates normal condition
- Pwr is the Power LED. It has the following state:
 - GREEN indicates the module is receiving power

Port Status LEDs

The port status LEDs have the following states:

- Off indicates that the port is disabled or the link is down
- GREEN indicates that the link is established

Ports

You can configure any two of the sixteen ports as an inline tool port pair and connect an inline tool to them.

For tool ports, you can also use ports on any module in the chassis, including ports on other bypass combo modules or ports on other GigaVUE-HC2 modules.

Ports have the following labels: X1 to X16. In the CLI, these ports are referred to as: x1 to x16.

Inline Network Ports

Connect inline networks to the inline network ports. The inline network ports have built-in protection for power down.

The inline network ports have the following labels:

- A—Inline network port A (for network 1 through network 4)
- B—Inline network port B (for network 1 through network 4)

NOTE: In the CLI, these ports are referred to as: x17 to x24.

The inline network ports on BPS-HC0-D25A4G and BPS-HC0-D25B4G are colored yellow to indicate short range. The inline network ports on BPS-HC0-D35C4G are colored blue to indicate long range.

The inline network port status LEDs have the following states:

- Off indicates that the port is disabled or the link is down
- GREEN indicates that the link is established

NOTE: In HC2 BPS cards, the power level of an inline-network port will stay close to zero even when it is brought down by Link Fail Propagation (LFP). In such circumstances, since the power-level of the inline network port is high, the connected port may also continue to stay up.

Mode

Mode (M) has the following labels:

- Off—Bypass

- On—Inline

The Mode LED has the following states:

- RED indicates that physical bypass is disabled
- Off indicates that physical bypass is enabled

Using Bypass Combo Modules for Gigamon Resiliency for Inline Protection

Gigamon Resiliency for Inline Protection (GRIP)[™] is an inline bypass solution that connects two GigaVUE-HC2 nodes together so that one node provides high availability to the other node when there is a loss of power. This redundant arrangement of two GigaVUE-HC2 nodes maintains traffic monitoring by inline tools when one of the nodes is down.

GRIP[™] makes use of the bypass protection switch relays for protected inline networks on GigaVUE-HC2 nodes. The bypass combo modules can provide physical protection for protected pairs of optical inline network ports required by the GRIP solution.

To configure the GRIP solution, the GigaVUE-HC2 must be running GigaVUE-OS version 4.4 or higher. For solution and configuration information, refer to the chapter “Configuring Inline Bypass Solutions” in the *GigaVUE-OS CLI Reference Guide*.

40Gb Bypass Combo Module

There is one 40Gb Bypass Combo Module as follows:

- Bypass Combo Module with two SR4 (50/125µm multimode) inline network port pairs and eight regular SFP+ port cages (BPS-HC0-Q25A28). The module also supports 4x10Gb breakout mode which when configured will support eight inline network port pairs. Refer to [Figure 16Bypass Combo Module BPS-HC0-Q25A28](#).

Before installing the bypass combo module, the GigaVUE-HC2 must be running software version 5.0 or higher.

For internal transceiver and loss summary specifications, refer to [Bypass Combo Module Specifications](#).

NOTE: The BPS-HC0-Q25A28 can only be used on a GigaVUE-HC2 node equipped with GigaVUE-HC2 Control Card version 2 (HC2 CCv2).

Features of the 40Gb Bypass Combo Module

The 40Gb Bypass Combo Module has the following features:

- Two 40Gb inline network port pairs that pass traffic bi-directionally.
- Port pairs that offer optical protection switch for physical bypass.
- Eight regular SFP+ ports that can operate at 1Gb or 10Gb and that can be configured as any port type.
- A mode to select either bypass or inline.
- A module that is hot swappable. Refer to procedures in [Module Removal and Replacement Procedure \(Hot Removal\)](#).

BPS-HC0-Q25A28

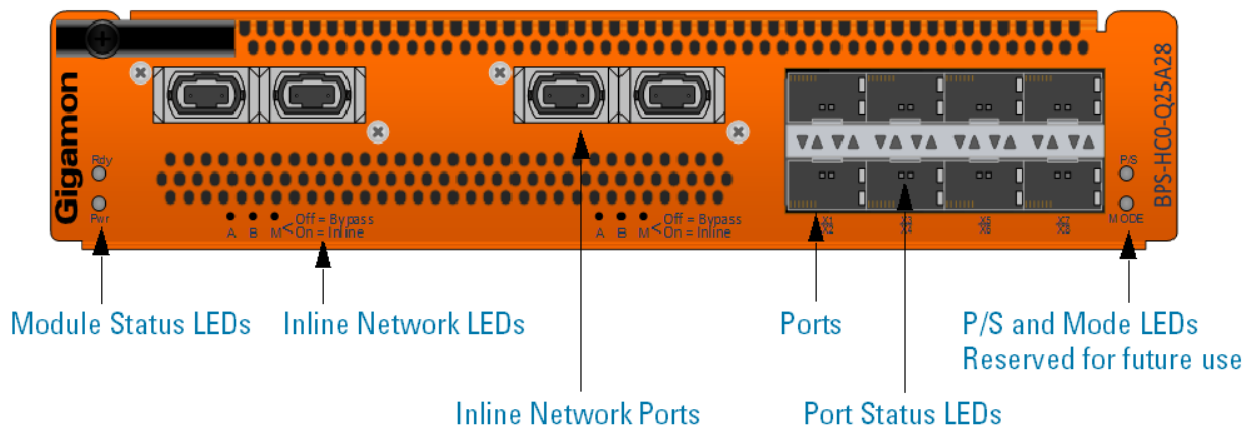

Figure 16 Bypass Combo Module BPS-HC0-Q25A28

Module Status LEDs

The following module status LEDs are located on the front of the bypass combo module:

- Rdy is the Ready LED. It has the following states:
 - RED indicates system booting or module down
 - GREEN indicates normal condition
- Pwr is the Power LED. It has the following state:
 - GREEN indicates the module is receiving power

Port Status LEDs

The port status LEDs have the following states:

- Off indicates that the port is disabled or the link is down
- GREEN indicates that the link is established

Ports

You can configure any two of the eight 10Gb ports as an inline tool port pair and connect an inline tool to them.

For tool ports, you can also use ports on any module in the chassis, including ports on other bypass combo modules or ports on other GigaVUE-HC2 modules.

Ports have the following labels: X1 to X8. In the CLI, these ports are referred to as: x1 to x8.

Inline Network Ports

Connect inline networks to the inline network ports. The inline network ports have built-in protection for power down.

The inline network port status LEDs have the following labels:

- A—Inline network LED A (for network 1 through network 2)
- B—Inline network LED B (for network 1 through network 2)
- M—Inline network Mode LED (on is inline and off is bypass)

The inline network port status LEDs have the following states:

- Off indicates that the port is disabled or the link is down

- GREEN indicates that the link is established

NOTE: In the CLI, the inline network ports are referred to as q1 to q4.

Using Bypass Combo Modules for Gigamon Resiliency for Inline Protection

Gigamon Resiliency for Inline Protection (GRIP)[™] is an inline bypass solution that connects two GigaVUE-HC2 nodes together so that one node provides high availability to the other node when there is a loss of power. This redundant arrangement of two GigaVUE-HC2 nodes maintains traffic monitoring by inline tools when one of the nodes is down.

GRIP[™] makes use of the bypass protection switch relays for protected inline networks on GigaVUE-HC2 nodes. The bypass combo modules can provide physical protection for protected pairs of optical inline network ports required by the GRIP solution.

To configure the GRIP solution, the GigaVUE-HC2 must be running GigaVUE-OS version 5.1 or higher. For solution and configuration information, refer to the chapter "Configuring Inline Bypass Solutions" in the *GigaVUE-OS CLI User's Guide*.

GigaSMART Rear Module

GigaVUE-HC2 nodes with a GigaSMART Rear module installed can take advantage of GigaSMART's advance processing features, including masking, slicing, tunnel decapsulation, VLAN tag insertion, de-duplication, header stripping, Adaptive Packet Filtering (APF), NetFlow generation, GTP stateful filtering, and flow sampling. You can use both GigaVUE-FM and the CLI to create GigaSMART operations combining different packet processing features, combine them with other map rule criteria, and apply them in map rules on any network port in the node.

Refer to the **GigaVUE-OS CLI Reference Guide** for details on the GigaSMART features.

GigaSMART SMT-HC0-R

The GigaSMART-HC0-R set of advanced features relies on on-board processing and backplane connections.

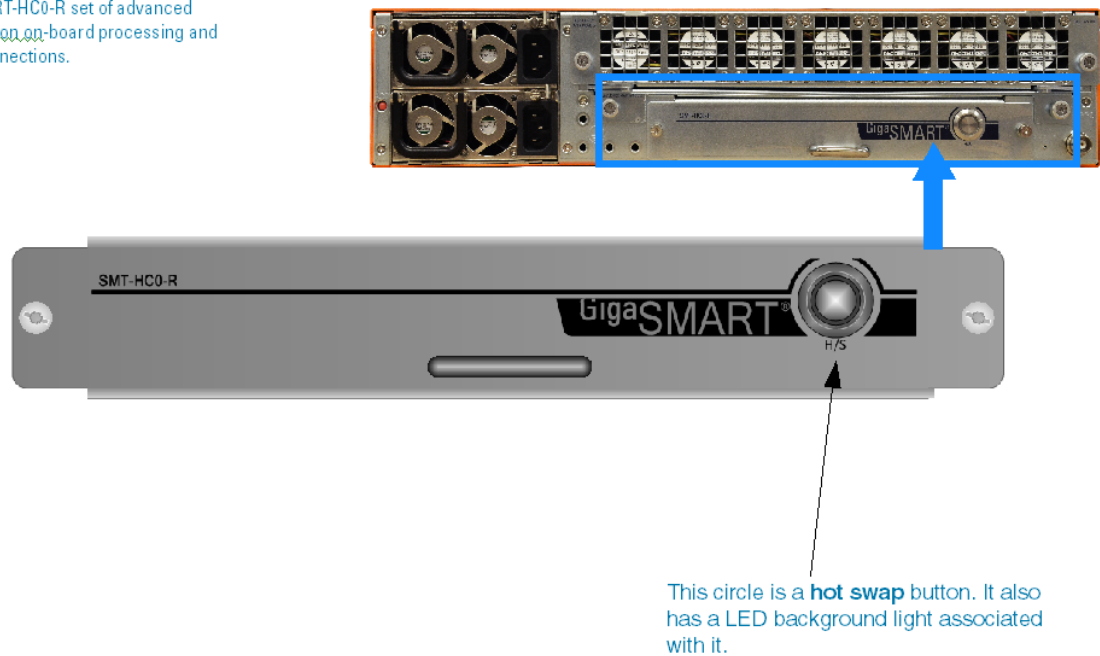

Figure 17 GigaSMART Rear Module

Hot Swap Button LED

The hot swap (H/S) button has a BLUE LED with the following states:

- Off indicates that the module is ready to configure. When the LED is Off, the module is operating normally in the node.
- On indicates that the module is ready to be removed.

When the H/S button is pressed on an inserted module, the LED turns solid BLUE. For the hot swap procedure, refer to [Removing the Rear GigaSMART Module](#).

GigaSMART Front Module

The GigaSMART Front module is a front-facing GigaVUE-HC2 module blending GigaSMART intelligence and port capabilities into a single module. GigaSMART licenses enable a variety of capabilities from packet de-duplication to NetFlow generation.

GigaVUE-HC2 nodes with a GigaSMART Front module installed can take advantage of GigaSMART's advanced processing features, including masking, slicing, tunnel decapsulation, VLAN tag insertion, de-duplication, header stripping, Adaptive Packet Filtering (APF), NetFlow generation, GTP stateful filtering, and flow sampling. Refer to the **GigaVUE-OS CLI User's Guide** for details on the GigaSMART features. The GigaSMART Front module also has SMT-HC0-X16 with sixteen 10Gb SFP+ and SFP Copper ports and SMT-HC0-Q02X08 with two 40Gb ports and eight 10Gb/1Gb SFP+ and SFP ports .

The GigaSMART Front module can be used standalone, or combined with other GigaSMART modules located in either the front or rear of the node. Since each GigaSMART module has its own compute engine, additional modules may be added as more compute power is required. The processing is not limited to the ports on the module. GigaSMART functionality is available to all ports within a clustered environment. Before installing the GigaSMART Front module, the GigaVUE-HC2 must be running software version 4.1 or higher.

For details about the supported transceivers, cable types, and connectivity specifications, refer to “GigaVUE-OS Compatibility and Interoperability Matrix”.

GigaSMART Front Module in GigaVUE-HC2

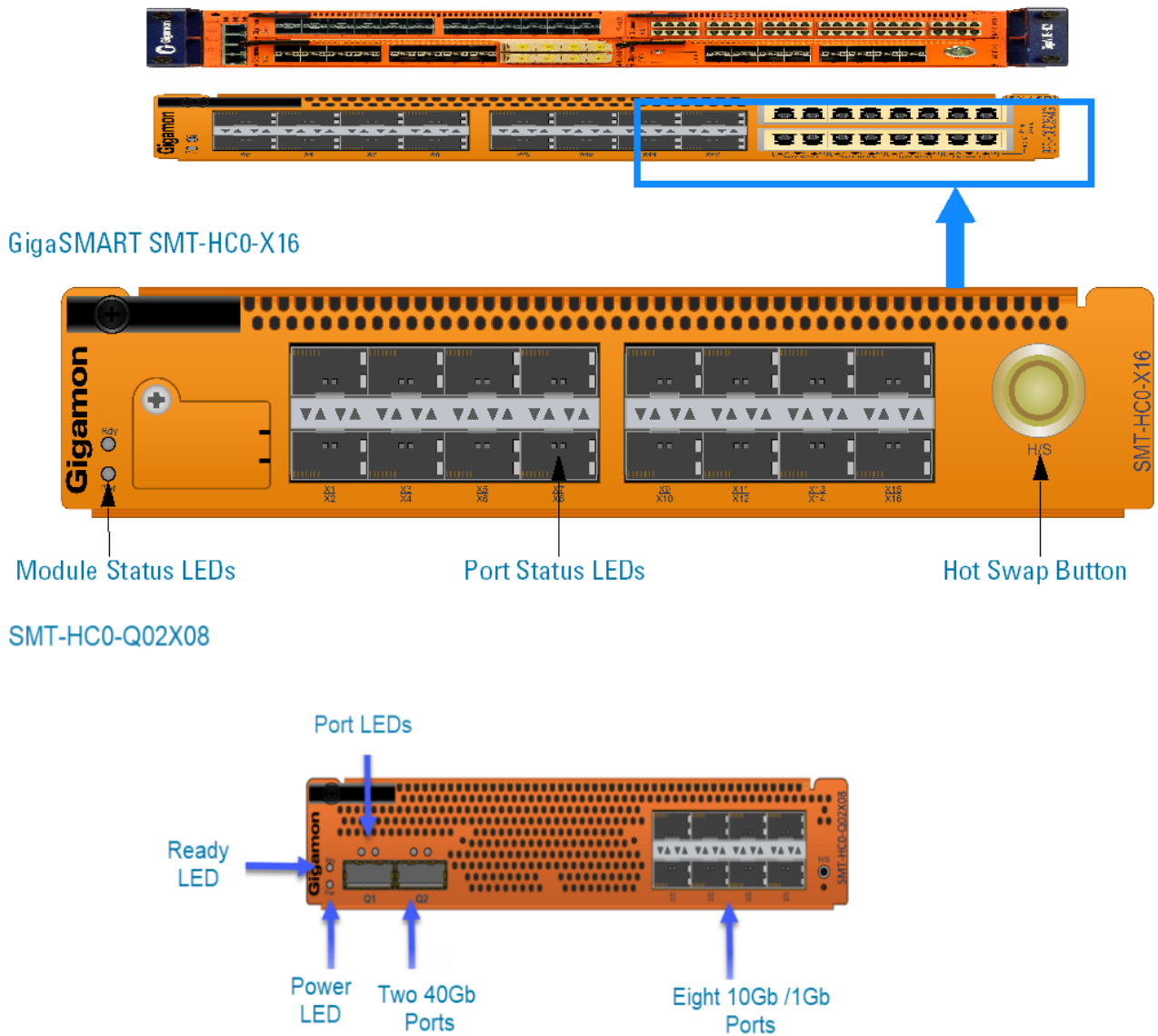

Figure 18 GigaSMART Front Module

Module Status LEDs

The following module status LEDs are located on the front of the GigaSMART Front module:

- Rdy is the Ready LED. It has the following states:
 - RED indicates system booting or alarm condition
 - GREEN indicates normal condition
- Pwr is the Power LED. It has the following state:
 - GREEN indicates the module is receiving power

Port Status LEDs

The port status LEDs have the following states:

- Off indicates that the port is disabled or the link is down
- GREEN indicates that the link is established

Hot Swap Button

Use the hot swap (H/S) button to put the GigaSMART Front module in a shutdown state.

The H/S button has a BLUE LED with the following states:

- Off indicates that the module is ready to configure. When the LED is Off, the module is operating normally in the node.
- Blinking indicates that the H/S button has been pressed.
- On (solid BLUE) indicates that the module is ready to be removed.

To remove a GigaSMART Front module, refer to the procedure [Removing the Front GigaSMART Module](#).

GigaVUE-HC2 Installation Roadmap

This chapter provides a flow chart of the major steps you need to perform to get a GigaVUE-HC2 node unpacked, rack-mounted, installed, and connected. It also describes what you should do once you have completed the initial setup of the node. Refer to the following sections for details:

- [First Steps – Getting Unpacked, Racked, Installed and Connected](#)
- [Next Steps](#)

First Steps – Getting Unpacked, Racked, Installed and Connected

You have received your GigaVUE-HC2 node and now you are ready to get up and running. [Figure 1Getting Started Roadmap](#) shows the major steps you need to perform to get the GigaVUE-HC2 chassis out of the box, into a rack, installed with modules, plugged in, and running on your network.

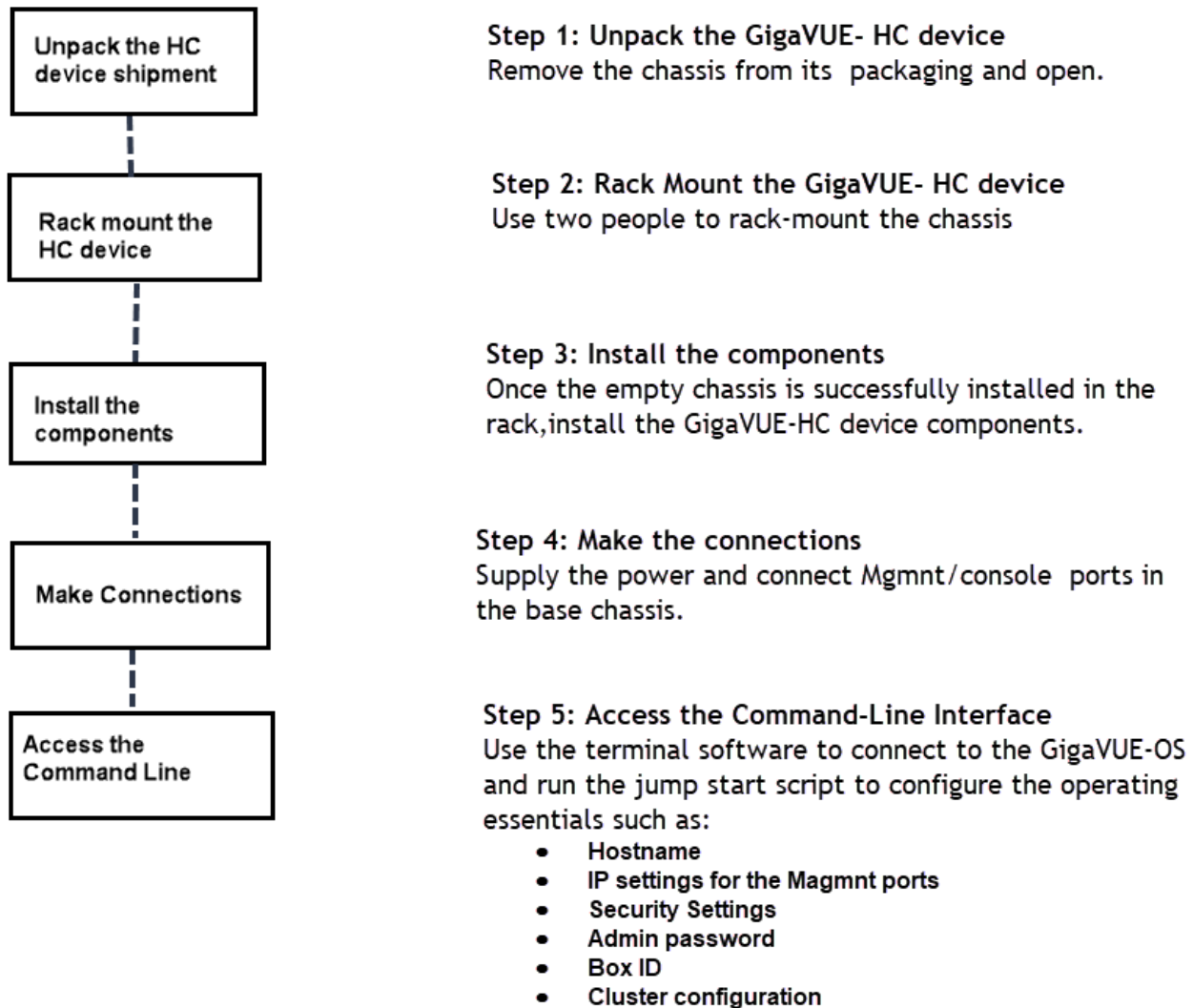

Figure 1 Getting Started Roadmap

Next Steps

Once you have performed the initial configuration of the GigaVUE-HC2 node, installing, connecting, and configuring the node, you are ready to get started mapping traffic between network and tool ports.

Refer to the *GigaVUE-OS CLI Reference Guide* and online help for information.

Assembling the GigaVUE-HC2 Node

This chapter explains how to unpack, rack-mount, and assemble the GigaVUE-HC2 node using the components that came with your shipment.

Separate sections are provided for unpacking and rack-mounting the GigaVUE-HC2 nodes. However, the instructions for installing control cards and modules are mostly identical and are covered in single sections. Refer to the following sections for details:

- [Unpacking the GigaVUE-HC2 Shipment](#)
- [Rack-Mounting the GigaVUE-HC2 Chassis](#)
- [Installing Power Modules in the GigaVUE-HC2 Chassis](#)
- [Installing Control Card in the GigaVUE-HC2 Chassis](#)
- [Installing the Rear GigaSMART Module](#)
- [Removing the Rear GigaSMART Module](#)
- [Removing the Front GigaSMART Module](#)
- [Installing and Removing Modules Procedure](#)
- [Module Removal and Replacement Procedure \(Hot Removal\)](#)

Unpacking the GigaVUE-HC2 Shipment

The GigaVUE-HC2 node is shipped partially assembled. The chassis and parts kit are shipped in one box – control card and modules are shipped in their own separate boxes. Use the following procedure to unpack the node:

1. Inspect the shipping boxes. If any of the cartons were damaged, file a claim with the carrier who delivered them.
2. Open the box containing the GigaVUE-HC2 chassis and remove the parts kit from the top of the shipment. The parts kit contains the power cords, console cable and adapter, optional cable management assembly, and power supply covers.

If you plan on installing the optional cable management assembly, set both the assembly and its matching custom rack ear aside for installation.

3. Open the following additional boxes and set them aside for assembly (each control card and module is shipped in separate boxes):
 - control card (one per chassis)
 - modules

4. Leave all protective filler panels in place in the chassis. **DO NOT** install the control card or modules yet. Gigamon recommends rack-mounting the GigaVUE-HC2 chassis empty because of its weight (~37lb).

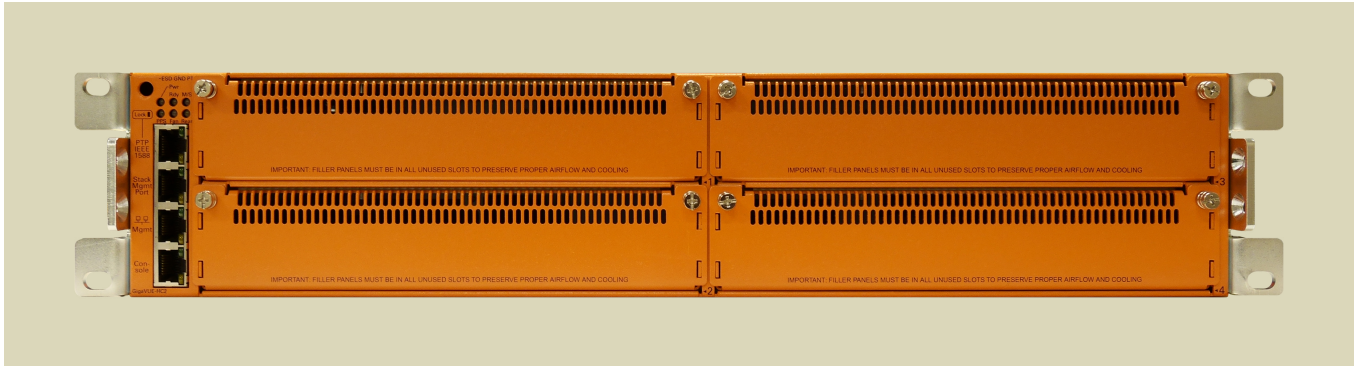

Figure 1 GigaVUE-HC2

Rack-Mounting the GigaVUE-HC2 Chassis

This section describes how to rack-mount the GigaVUE-HC2 chassis in a standard 2RU rack space using the hardware provided with the chassis. You can install the GigaVUE-HC2 chassis in two-post or four-post racks with a minimum depth of 16in.

Safety Precautions

Before you get started rack-mounting the GigaVUE-HC2 chassis, make sure you have read the following safety precautions:

- There are a wide variety of racks available on the market. Make sure you consult the instructions provided by your rack vendor for detailed mounting instructions before installing the GigaVUE-HC2 chassis.
- Make sure you install any stabilizers provided for the rack before installing the chassis. Unsecured racks can tip over and cause injury or death.
- Make sure you install devices in the rack from the bottom up with the heaviest devices at the bottom.
- Make sure you provide adequate ventilation to the nodes installed in the rack.

Rack-Mounting Procedure

Use the following procedure to rack-mount the GigaVUE-HC2 chassis and install the optional cable management assembly:

1. **Decide whether you want to front-mount or center-mount the chassis in the rack.** Front-mounted nodes will sit flush with the front of the rack while center-mounted nodes will extend in front of it.

The GigaVUE-HC2 chassis is shipped with its standard rack ears attached facing forward in the front-mount position. You can reverse the direction of the rack-ears to center-mount the node.

IMPORTANT: The optional cable management assembly can only be used when front-mounting the GigaVUE-HC2 chassis. Refer to the next step for details.

Front-Mount GigaVUE-HC2

Front-Mount Position (As Shipped)

Rack ears face towards the front of the node for front-mounting.

Center-Mount Position

Reverse the rack ears so they face towards the rear of the node for center-mounting.

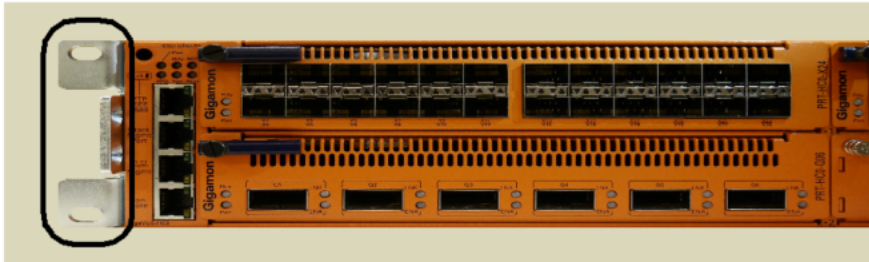

Figure 2 Rack Ears for Front Mount (Reverse Rack Ears for Center Mount)

2. Make sure you have not installed any modules in the chassis yet. Gigamon recommends rack-mounting the GigaVUE-HC2 chassis before installing these items to make it easier to handle during the installation.
3. Select a suitable location for the rack that will hold the GigaVUE-HC2 chassis. Choose a location that is clean, dust free, and well-ventilated. You will need access to grounded power sources. Avoid areas where heat, electrical wire, and electromagnetic fields are generated.

Plan for enough clearance in front of a rack so you can access the modules easily (approximately 25in) and enough clearance in the back of the rack to allow sufficient airflow and installation of the rear components such as power supplies. Also, if you plan to install the optional cable management assemblies, allow another 3.5in of clearance at the front of the node.

4. Locate an open 2RU rack space and lift the node into place. It takes two people, or a scissor lift to place the GigaVUE-HC2 in the rack. Insert a screw through the rack ear on each side into the rack, to hold the node in place. Tighten the screws.
5. Carefully lift the chassis into the rack and place a screw on each side to hold the chassis.
6. Tighten the screws and add additional screws to secure the node. **Use two screws on each rack ear.**

Four-Post Rack Mounting

To mount the GigaVUE-HC2 in a four-post rack, use rack ears and full-length brackets. The rack ears attach at the front of the unit and the brackets attach at the rear, as follows:

- Attach the rack ears so they face towards the front of the system for mounting in four-post racks.

- Attach the full-length brackets to the sides of the GigaVUE-HC2 with enough free play to position them to fit your rack's dimensions. After the brackets are attached to the rack's rear posts, tighten the bracket connections to the sides of the GigaVUE-HC2.

Refer to [Figure 3 Retracted and Extended Bracket Installation](#) for retracted and extended bracket installation.

Retracted Bracket

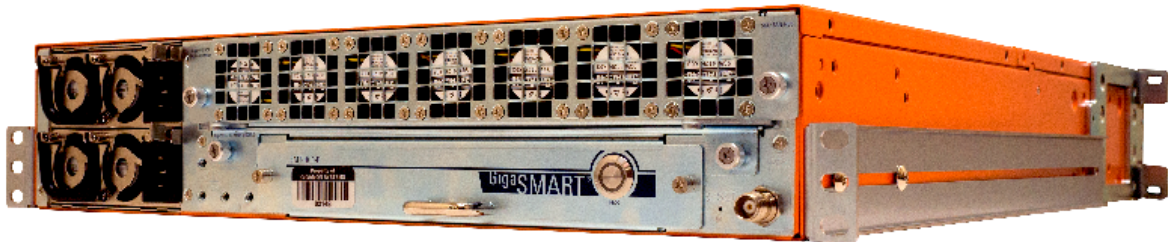

Extended Bracket

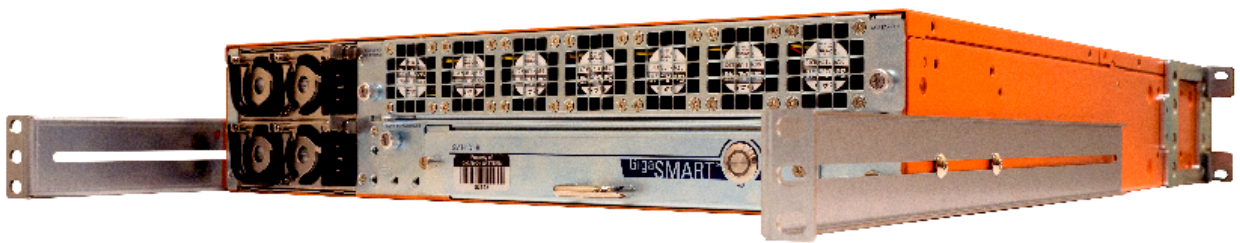

Figure 3 Retracted and Extended Bracket Installation

Installing Power Modules in the GigaVUE-HC2 Chassis

The GigaVUE-HC2 chassis is shipped without either of its two separate power modules installed. Use the following procedure to install them.

NOTE: If you are installing DC power modules, you will need to wire power to the screw terminals on the power modules before installing them in the chassis. There is not enough room to service the screw terminals once the modules are installed in the chassis. Refer to [Connecting -48V DC Power Supplies](#) for instructions on connecting DC power modules.

1. Make sure you are wearing an ESD-preventive wrist or ankle strap.

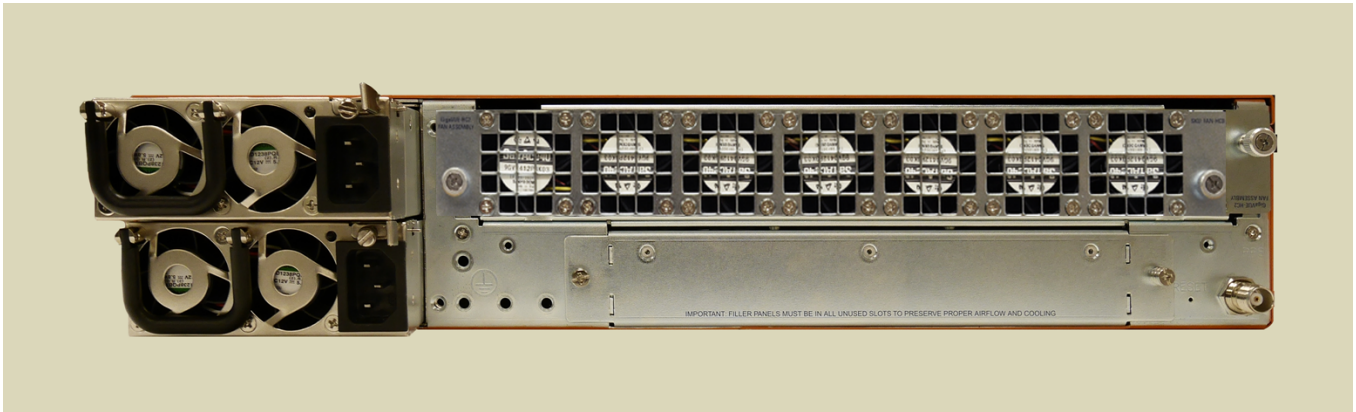

Figure 4 Power Module (AC Version Shown)

2. Locate the power modules and remove them from their packaging. Each module is shipped in its own box.
3. Carefully slide the first power module into the matching receptacles at the rear of the node ([Figure 4 Power Module \(AC Version Shown\)](#)), making sure to fit the tab at the base of the module into the matching bay at the bottom of the receptacle. Push gently to seat the unit firmly in the chassis.
4. Tighten the thumb screws to lock the power module into the chassis.
5. Repeat the previous two steps for the second power module.

Installing the Cable Management Trays in the GigaVUE-HC2 Chassis

Decide whether you want to install the optional cable management assembly.

The GigaVUE-HC2 chassis includes two cable management trays for installation at the side of the node. Installing the cable management trays is optional. However, because of the high number of ports potentially available on the GigaVUE-HC2 node, Gigamon recommends installing the cable management trays. Use the following procedure:

1. Remove the cable management trays from the foam packaging shipped on top of the GigaVUE-HC2 chassis ([Figure 5 Cable Management Trays](#)).

Cable Management Trays as shipped.

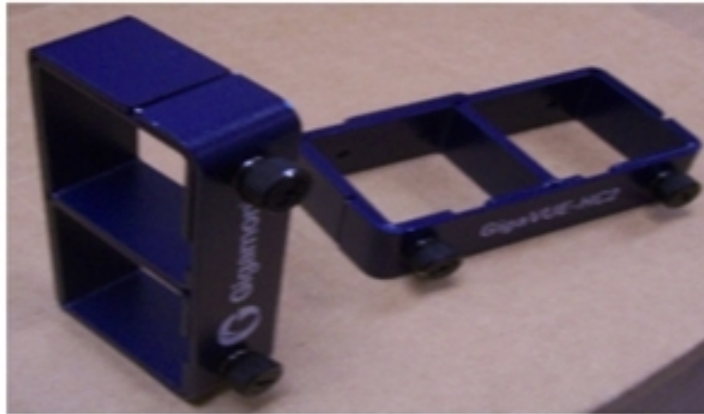

Figure 5 Cable Management Trays

2. Remove the front panel from each of the cable management trays by loosening the thumb screws.
3. The cable management assembly is included in the parts kit with the chassis shipment. Installation of the cable management assembly is optional. To install the cable management assembly on the GigaVUE-HC2 node, you must attach it to the rack ear on the left and right sides of the chassis rack ear:
 - a. Locate the cable management assembly ([Figure 6 GigaVUE-HC2 Cable Management Assembly and Rack Ear](#)).

Cable Management Assembly attaches to rack ear for GigaVUE-HC2 node.

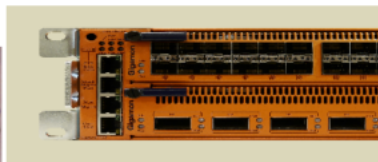
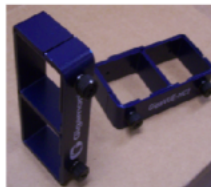

Figure 6 GigaVUE-HC2 Cable Management Assembly and Rack Ear

- b. Attach the Cable Management assembly to the forward facing rack ear tab with two machine screws.

Rack Ear for Cable Management

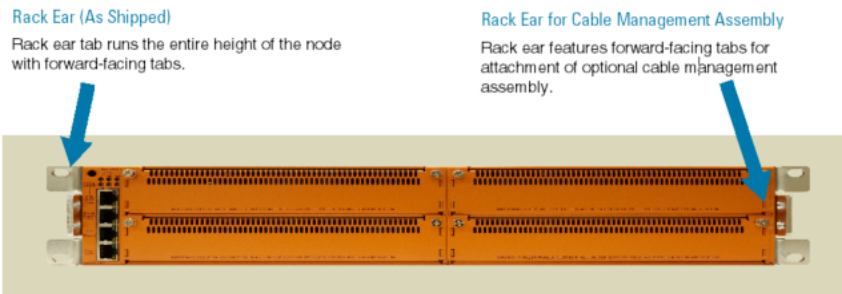

Figure 7 Standard Rack Ears on GigaVUE-HC2

If you installed the custom rack ear for the cable management assembly in [Step](#) , you can now attach the assembly using the four screws provided. The screws attach through the recessed holes on the inside of the rack ear and into the cable management assembly, as shown in [Figure 8 Cable Management Assembly Attached to Node](#).



Cable Management Assembly Attached
The screws attach from the inside of the tabs. You may need to partially remove the modules in bays 1 and 4 to fully attach the cable management assembly screws.

Figure 8 Cable Management Assembly Attached to Node

4. As shown in [Figure 8 Cable Management Assembly Attached to Node](#), the thumb screws on the cable management assembly's front panel allow quick removal and reattachment whenever you want to route cables.
5. Use the provided screws to attach the lower halves of the cable management tray to the top and bottom of the GigaVUE-HC2 chassis. Each lower half has a protruding "lip" on one side of the assembly – position this lip so you can route cables into the assembly.
 - Attach the top assembly with the lip at the top of the node.
 - Attach the bottom assembly with the lip at the bottom of the node

This completes the assembly of the cable management trays on the GigaVUE-HC2.

Installing Control Card in the GigaVUE-HC2 Chassis

Once the GigaVUE-HC2 chassis is successfully installed in the rack, you are ready to start building up the node. Start by installing the control card in the rear of the GigaVUE-HC2.

- **Avoid Electrostatic Damage!**

■ Control Card Installation Procedure

NOTE: Refer to [Control Card Installation Procedure](#) for control card replacement procedures in a variety of different deployment scenarios.

Avoid Electrostatic Damage!

IMPORTANT: Always take precautions to avoid electrostatic damage during control card and module installation:

- Always use an ESD-preventive wrist or ankle strap and ensure that it makes good skin contact. The strap can be connected to one of the following:
 - ESD wrist strap connector. The GigaVUE-HC2 chassis provides a connector at the front of the chassis for this purpose labeled **ESD GND PT.**
 - Captive installation screws on an installed module or power supply.
 - Any unpainted surface on the chassis.
- Handle cards by the edges only.
- Avoid contact between the cards and clothing. The wrist strap protects only the module from ESD voltages on the body. ESD voltages on clothing can still cause damage.

Control Card Installation Procedure

Use this procedure for initial installation of GigaVUE-HC2 control cards, either the original control card or HC2 CCv2.

IMPORTANT: Because there is only one control card, hot swapping is not possible.

1. Make sure you are wearing an ESD-preventive wrist or ankle strap.
2. Remove the protective fan tray from the back of the unit. This opens the area to insert the control card.

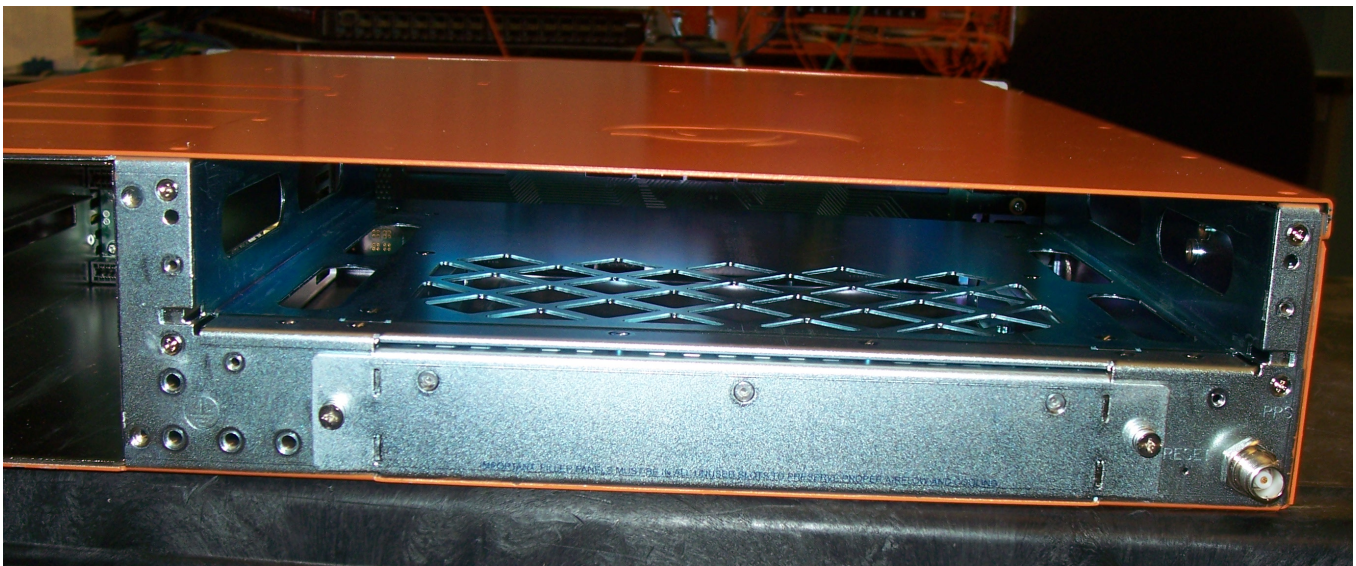
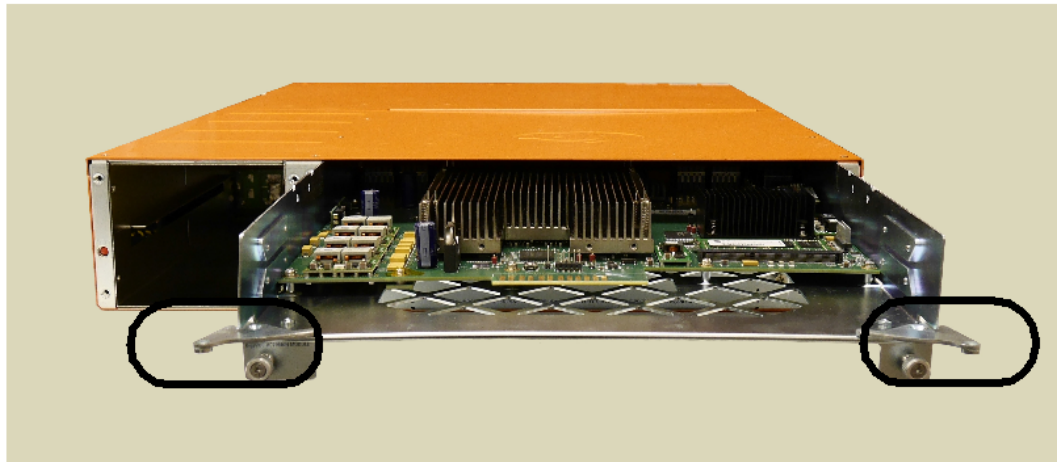

Figure 9 Back of Node Shows Opening for Control Card

3. Locate the control card and remove it from its packaging.
4. Carefully align the tabs at the sides of the control card rack.
5. Slide the control card into the guides until it is firmly connected at the back of the card.

GigaVUE-HC2 Control Card Assembly



When fully inserted, close the latches on the two back corners and attach the screws into the frame.

Figure 10 *Installing Control Card to the rear of the GigaVUE-HC2*

This completes the installation of the control card on the GigaVUE-HC2.

Installing the Rear GigaSMART Module

Use the following procedure to install the rear GigaSMART module with the power on. For installing other GigaVUE-HC2 modules, refer to [Module Installation Procedure](#).

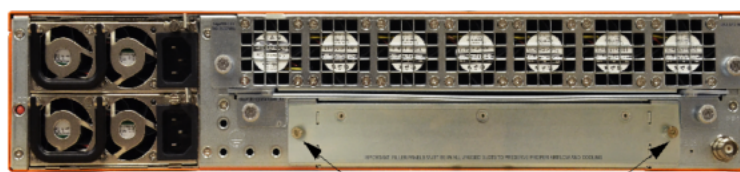

Bay for the rear GigaSMART

Captive screws

The rear GigaSMART module is installed as follows:

1. Unpack all the components of the GigaVUE-HC2, and view the rear of the chassis.
2. Remove the filler panel covering the bay below the fan assembly by removing the two captive screws.

NOTE: Do not remove the filler panel if you do not plan to install a GigaSMART module in that bay.

3. Insert the GigaSMART module into the open bay and fasten by tightening the two captive screws.



Removing the Rear GigaSMART Module

Use the following procedure to remove the rear GigaSMART module from the node with the power on.

For removal of other GigaVUE-HC2 modules, refer to [Module Removal and Replacement Procedure \(Hot Removal\)](#).

IMPORTANT: Hot removal of the GigaSMART module without following the listed steps can cause system instability and require a reboot.

Before starting, make sure you are wearing an ESD-preventive wrist or ankle strap.

1 Save map rules with the following CLI command:

```
config text generate active running save <name.txt>
```

Refer also to [Backing Up Running Configuration](#).

1. Press the H/S button to prepare the module for removal. Wait for the LED to turn solid blue.
2. Slide the module out of chassis and store it in a static-safe location.
3. Insert the new GigaSMART module.
4. To verify the module is operationally up, issue the following CLI command:

```
(config) # show cards
```

5. Apply GigaSMART licenses with the following CLI command:

```
license install box id <#> key
```

Backing Up Running Configuration

Use the information in this section to back up the running configuration.

Use the following command to back up to a SCP/TFTP/HTTP server:

```
(config) # configuration text generate active running upload <upload URL> <filename>
```

This command uses FTP, TFTP, or SCP to upload the running configuration to a text file on remote storage. The format for the **<upload URL>** is as follows:

```
[protocol]://username[:password]@hostname/path/filename
```

For example, the following command uploads a text configuration file based on the active running configuration and uploads it to an FTP server at 192.168.1.49 with the name **config.txt**:

```
(config) # configuration text generate active running upload
ftp://myuser:mypass@192.168.1.49/ftp/config.txt
```

Removing the Front GigaSMART Module

Use the following procedure to remove the front GigaSMART module from the node with the power on. The procedure shuts down the GigaSMART port, the sixteen 10Gb SFP+ ports (SMT-HC0-X16) and two 40Gb ports and eight 10Gb/1Gb SFP+ and SFP ports (SMT-HC0-Q02X08) on the front GigaSMART module.

For removal of other GigaVUE-HC2 modules, refer to [Module Removal and Replacement Procedure \(Hot Removal\)](#).

IMPORTANT: Hot removal of the GigaSMART module without following the listed steps can cause system instability and require a reboot.

Before starting, make sure you are wearing an ESD-preventive wrist or ankle strap.

1. Save map rules with the following CLI command:

```
config text generate active running save <name.txt>
```

Refer also to [Backing Up Running Configuration](#).

2. To prepare the module for removal, press and hold the H/S button, then release it. The LED will blink for a few seconds.

NOTE: Pressing the H/S button is the same as issuing the following CLI command:

```
(config) # card slot <slot ID> down
```

3. Wait for the module to shut down: Rdy LED goes red; H/S LED goes solid blue.
4. Slide the module out of the chassis and store it in a static-safe location.
5. Insert the new GigaSMART module.
6. Wait for the module to come back up: Rdy LED goes green; H/S LED goes off.
7. To verify the module is operationally up, issue the following two CLI commands:

```
(config) # show cards (config) # show card slot <slot id>
```

NOTE: The output of the **show cards** command displays the operational status of the GigaSMART Front module as up in the Oper Status field, as follows:

```
(config) # show cards
Slot  Config  Oper Status HW Type      Product Code  Serial Num  HW Rev-----
-----
cc1   yes      up      HC2-Main-Board  132-00AN     1AN0-00E4   B1-251     yes
      up      SMT-HC0-X16  132-00AT       1AT0-0151   A0-5
1     yes      up      SMT -HC0-Q02X08 132-00F7     1F70-0075   2.3-c
```

However, the processor on the GigaSMART Front module takes a minute to become operationally up. The **show card slot <slot id>** command displays the status of the card as well as the status of the processor. Issue the **show card slot <slot id>** command to verify the processor state in the e1 State field. You may have to issue the command a few times to watch the e1 State transition from down to up, as follows:

```
(config) # show card slot 1/1
Slot  Config  Oper Status      HW Type      e1 State  e2 State
-----1-----
      SMT-HC0-X16  down        N/A
(config) # show card slot 1/1
Slot  Config  Oper Status      HW Type      e1 State  e2 State
-----1-----
      SMT-HC0-X16  up          N/A
```

8. Apply GigaSMART licenses with the following CLI command:

```
license install box id <#> key
```

Installing and Removing Modules Procedure

The procedure for installing modules is to remove the filler panels, and install the module. Then fasten with the blue ejector lever and tighten the thumb screw on top of the lever. The following procedure has the details.

Hot Swapping Modules

Modules are hot-swappable – they can be installed or removed from the chassis with the power on. **To remove a module safely with the power on, you must follow the procedure in [Module Removal and Replacement Procedure \(Hot Removal\)](#).**

Install proper software versions prior to inserting any new modules.

Gigamon often makes new modules available for GigaVUE-HC2 nodes. New modules are usually introduced starting with a new software release. Make sure you install the supporting software release before physically installing the new module.

If you do install a new module before its supporting release, the module will appear in **show cards** output with an **Operational Status of unsupported**.

In some cases, if you subsequently upgrade the node to the release that does support the new module, it can appear persistently in the **show cards** output with an **Operational Status of inserted**. To make the module operational, you must unconfigure it with the **no card slot x** command, followed by configuring the module with **card slot x**.

Module Installation Procedure

Use the following procedure, for GigaVUE-HC2 modules, except the GigaSMART Rear module, which is described in [Installing the Rear GigaSMART Module](#).

1. Make sure you are wearing an ESD-preventive wrist or ankle strap.
2. Locate the modules and remove them from their packaging.

3. Remove the protective filler panels from the target bays for all modules to be installed. Keep the filler panels so they can be easily reused if the module is ever removed. You can install modules in any of the four available front bays on the GigaVUE-HC2 – the order is not important.

NOTE: To prevent any improper air flow and overheating the node, **do not leave any bays uncovered.**

4. Pull out the dark blue lever on the left top of the module. Carefully slide the module into the bay. Push the lever back in and tighten using the thumb screw on the lever..

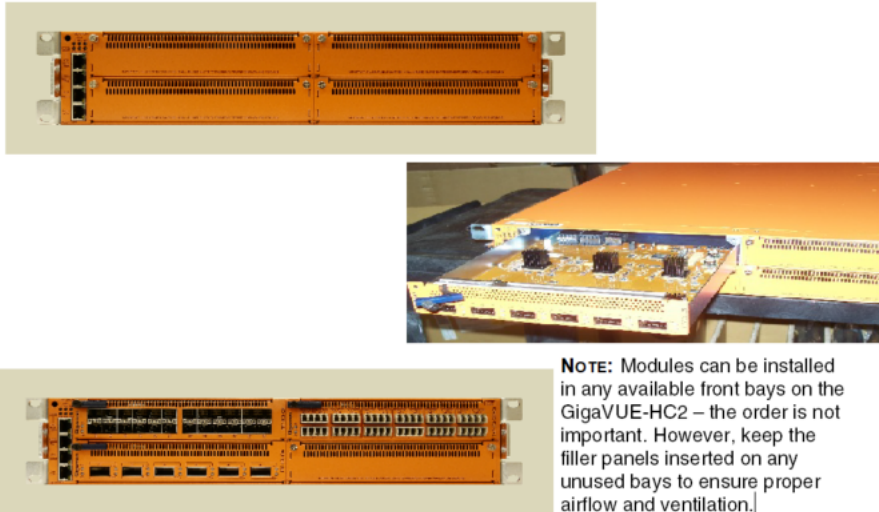

Figure 11 *Installing Modules*

5. Install any additional modules by repeating the previous two steps.

NOTE: The first time you install a module in the node, you need to configure the node to recognize it with the **card** command and save your changes with **write memory**. Refer to [Configure Modules and Enable Ports](#) for details.

This completes the installation of the modules on the front of the GigaVUE-HC2.

Module Removal and Replacement Procedure (Hot Removal)

Modules can be removed from the node with the power on.

Use the following procedure for GigaVUE-HC2 modules, except the GigaSMART modules described in [Removing the Rear GigaSMART Module](#) and [Removing the Front GigaSMART Module](#).

NOTE: Some larger transceivers (such as copper SFP+), when inserted into ports X1 and X3 on modules PRT-HC0-X24, BPS-HC0-D25A4G, BPS-HC0-D25B4G, and BPS-HC0-D35C4G, may physically interfere with opening or closing the module latch. When possible, use these transceivers in ports other than X1 and X3. Otherwise, the transceiver and cabling for those ports will first need to be removed prior to engaging the latch.

IMPORTANT: Hot removal of modules without following the listed steps can cause system instability and require a reboot.

Before starting, make sure you are wearing an ESD-preventive wrist or ankle strap.

Replacing a Module with the Same Type of Module

1. Shut down the module to prepare for removal with the following CLI command:
(config) # card slot <slot id> down
2. Slide the module out of the chassis and store it in a static-safe location.
3. Insert the new module of the same type.

Replacing a Module with a Different Type of Module

1. Remove all packet distribution configuration related to the module to be removed.
2. Shut down the module to prepare for removal with the following CLI command:
(config) # no card slot <slot id>
3. Slide the module out of chassis and store it in a static-safe location.
4. Insert the new module of the different type.
5. Issue the following CLI command to make the card available for configuration:

(config) # card slot <slot id>

Next Steps

Refer to [Configuring Basic GigaVUE H Series H Series Settings](#) for information on getting connected with the GigaVUE-OS to make your initial configuration settings.

Basic GigaVUE H Series Connections and Configuration

This chapter describes how to establish your first configuration session with the GigaVUE-HC2 and set the basic initial configuration options necessary to get the node up and running.

Refer to the following sections for details:

- [Grounding the GigaVUE-HC2 Chassis](#)
- [Connecting Power to the GigaVUE-HC2](#)
- [Fan Trays](#)
- [Connecting Serial Console and Mgmt Ports](#)
 - [Connecting -48V DC Power Supplies](#)
- [Configuring Basic GigaVUE H Series H Series Settings](#)
 - [Access the Command-Line Interface over the Console Port](#)
 - [Run the Jump-Start Script](#)
 - [Configure Modules and Enable Ports](#)
- [Command-Line Basics](#)
 - [Command-Line Modes](#)
 - [Entering Commands in the CLI](#)
 - [Command-Line Syntax – Entering Commands](#)
- [The Basic Commands](#)
- [Completing the Initial GigaVUE H Series H Series Setup](#)

Grounding the GigaVUE-HC2 Chassis



The GigaVUE-HC2 chassis is drilled for ground screws near the bottom left corner at the rear of the chassis. Connect grounding wire with spade lugs to the ground screws on the chassis and earth ground using the following procedure.

1. Locate the grounding points near the bottom left corner at the rear of the chassis to the right of the power plug. There are two pairs of grounding points as shown in [Figure 1](#) [Grounding Points for Ground Screws \(GigaVUE-HC2 Shown\)](#).
2. Install ground screws meeting the following specifications:
#8 Panhead, Phillips-drive, Exterior SEM screw. Thread size = 3/2 Length = 1/2in (1.27cm)

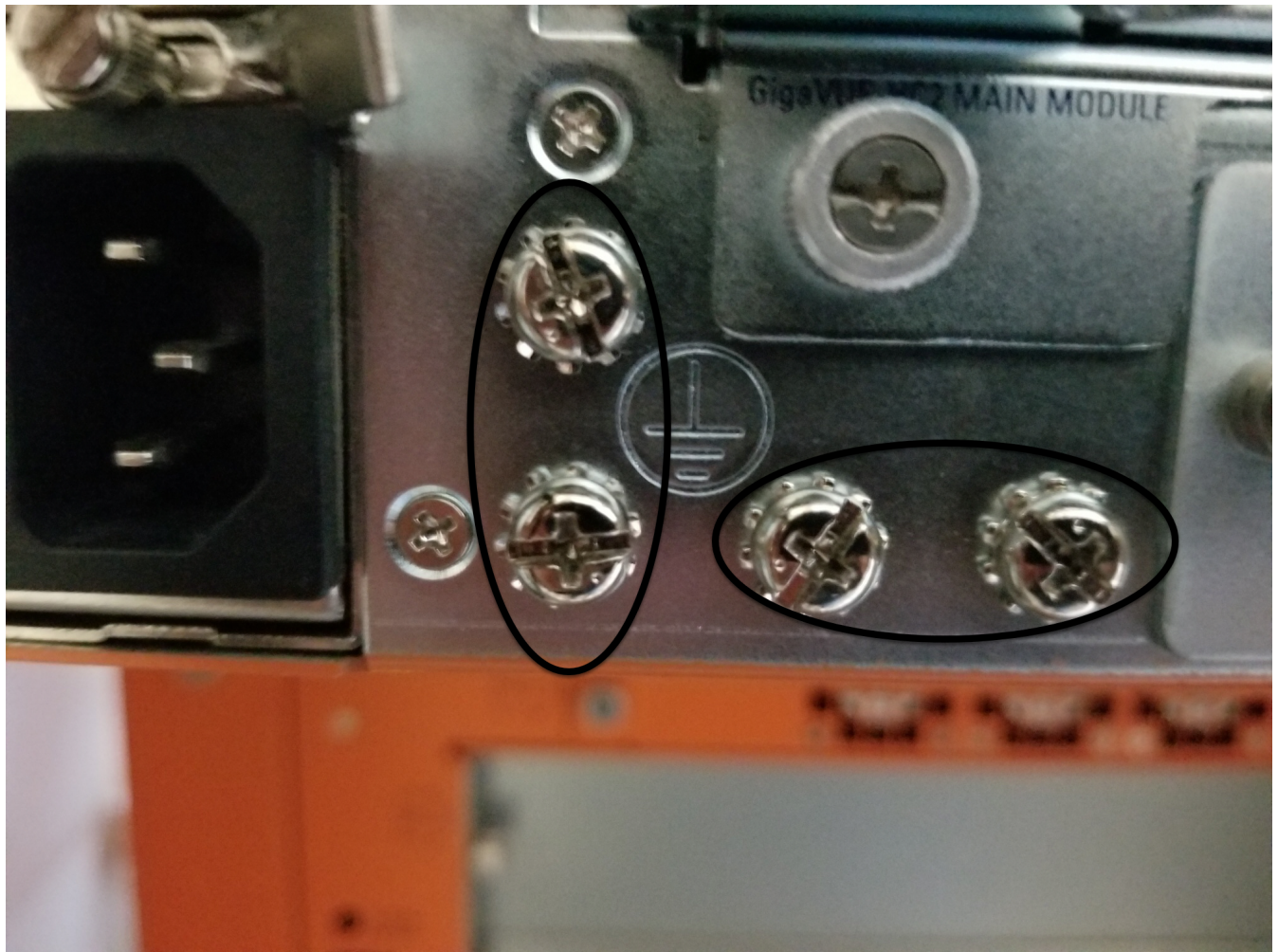

Figure 1 Grounding Points for Ground Screws (GigaVUE-HC2 Shown)

3. Connect grounding wire with spade lugs both to the ground screws and to earth ground. The specifications for the ground wire and lugs are as follows:
Standard Wire 12-16 (AWG); Stud Size #6 (0.138in/0.351cm); Spade Width 0.32in/0.813cm
4. Tighten the screws to secure both the chassis ground screws and the earth ground screws.

Connecting Power to the GigaVUE-HC2

The procedure for connecting power to the GigaVUE-HC2 is similar to the other GigaVUE H Series H Series nodes:

GigaVUE H Series Chassis Type	Number of Power Modules	Power Supplies per Modules
GigaVUE-HC2	2	1

In all cases only a single power module is required to operate the node. However, connecting both modules provides redundant power.

1. Plug an approved C13 power cable into each of the power modules at the rear of the GigaVUE-HC2 chassis.

NOTE: For information on connecting the optional DC power modules, refer to [Figure 4DC Power Module](#).

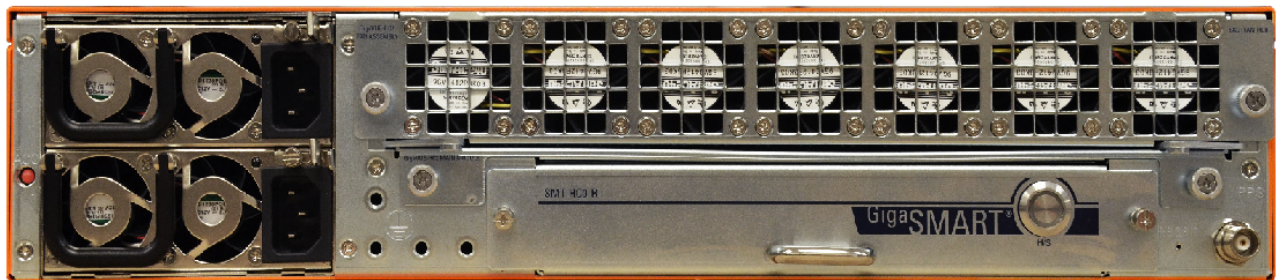

Power module -
Three-prong power
supply

Figure 2 Connecting AC Power (GigaVUE-HC2)

2. Plug the other end of the power cables into a power source that can supply adequate power. For optimal power protection, plug the power modules into separate circuits. When connecting to the external AC power source, ensure that a Surge Protective Device (SPD) is installed at the AC power inlet.

For information on GigaVUE-HC2 power requirements, refer to [AC- and DC-Powered GigaVUE-HC2](#).

3. Power is turned on when the unit is plugged in, and turned off when the unit is unplugged. Refer to [Connecting Serial Console and Mgmt Ports](#) for information on how to connect to the GigaVUE-OS command-line interface. To remove a power module, refer to [Removing a Power Module](#).

Removing a Power Module

When removing a power module, refer to the following label on the chassis:

Figure 3 Power Caution Label

To remove a power module:

1. Power down the module by disconnecting the power inputs.
2. Wait about 90 seconds for the node to stabilize.
3. Remove the power module.

NOTE: Do not remove a power module while inputs are still connected.

Connecting -48V DC Power Supplies

The GigaVUE-HC2 is available with DC power supplies. This section provides instructions for connecting a -48V DC power source to the DC power supplies.

To connect a -48V DC input to the screw terminal DC power supply:

1. Remove the safety cover from the power terminals.
2. Connect the power supply ground terminal () to earth ground.

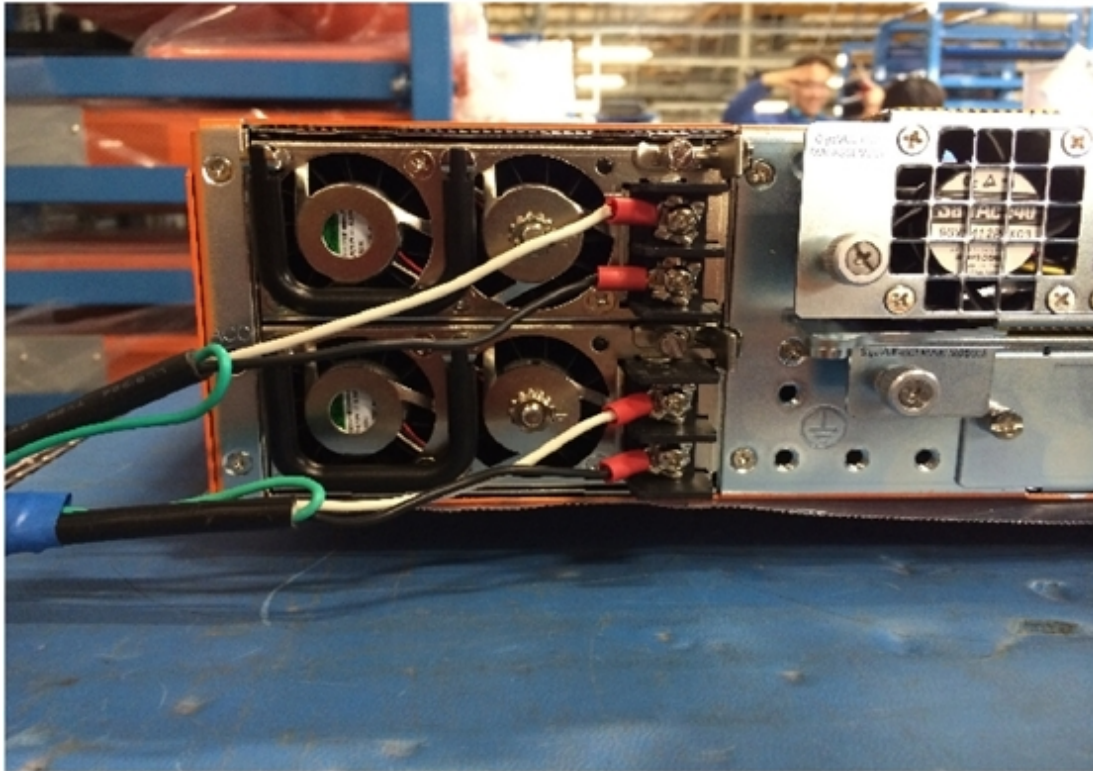

Figure 4 DC Power Module

3. Connect the positive and negative power cables to the screw terminals using a Phillips screwdriver.
 - o The top connector on the DC power supply is the **0V** connector.
 - o The bottom connector on the DC power supply is the **-48V** connector.
4. Replace the safety cover over the power terminals.
5. Connect the neutral and negative power cables to the DC power source as follows:
 - o Connect the neutral wire to the 0V (RTN) connector on the DC power source.
 - o Connect the negative wire to the -48V connector on the DC power source.

IMPORTANT: As shown in [Figure 4DC Power Module](#) , the leads to the DC power supplies on the GigaVUE-HC2 node should attach from the side of the chassis **away** from the terminal block. Run the wires to avoid obstructing airflow for the adjacent fans.
6. Repeat [Step 2](#) through [Step 5](#) for the other power supply in the GigaVUE-HC2 chassis:

- o **GigaVUE-HC2** – Two DC power supplies

Fan Trays

Fan trays are field-replaceable and hot swappable. If a fan tray fails, you replace the fan tray without powering down the GigaVUE-HC2. Refer to the following sections for details:

- [Checking Fan Status](#)
- [Configuring SNMP Notification](#)
- [Replacing a Fan Tray](#)

Checking Fan Status

A Fan LED is located on the front of the GigaVUE-HC2 chassis and provides fan status. The LED is green when the fans are operating and red when they are not. Refer to [Figure 5 Fan LED Location on GigaVUE-HC2 Front](#) for the location of the Fan LED.

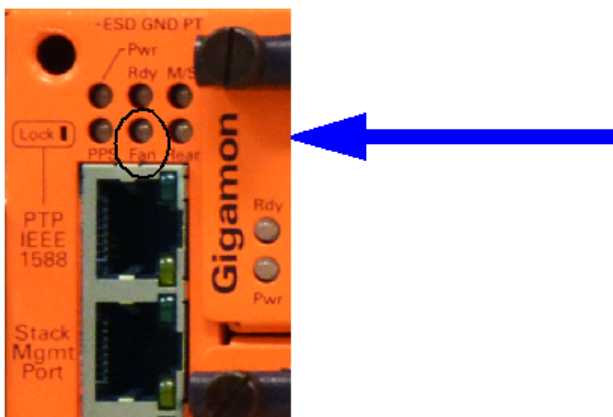

Figure 5 Fan LED Location on GigaVUE-HC2 Front

Configuring SNMP Notification

Use the following CLI command to configure a notification that will be sent when the fan status changes:

```
(config) # snmp-server notify event fanchange
```

Replacing a Fan Tray

Replace a failed fan tray with a working fan tray using the following procedures.

NOTE: Work quickly to remove the failed fan tray and insert the working fan tray. The GigaVUE-HC2 should not be without cooling for more than 60 seconds.

To remove a fan tray:

1. Locate the two screws on either side of the fan tray as shown in [Figure 6 Fan Tray Screw Location on GigaVUE-HC2 Rear](#).

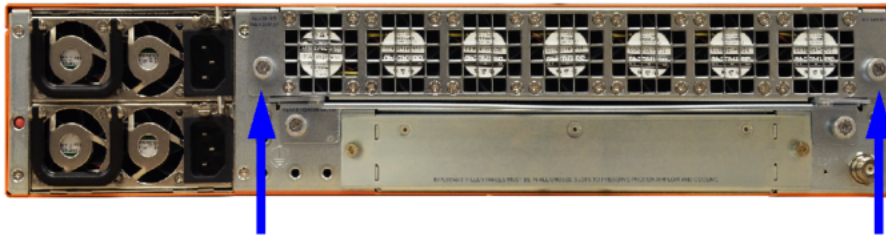

Figure 6 Fan Tray Screw Location on GigaVUE-HC2 Rear

2. Use a Phillips screw driver to remove the two screws.
3. Pull the failed fan tray out of the slot and set it aside.

To insert a fan tray:

1. Place the working fan tray into the empty slot and slide it in until it is flush with the chassis rear and will not slide in any further.
2. Use a Phillips screw driver to tighten the two screws.

Connecting Serial Console and Mgmt Ports

To make basic GigaVUE-HC2 connections (serial console and Mgmt ports):

1. Locate the DB9-to-RJ45 serial cable provided with the GigaVUE-HC2. This cable is called a *console cable*.

NOTE: This cable is Cisco-compatible. Refer to [Appendix D, Console Port Signaling and Cabling](#) for pinout details.

2. Connect the RJ45 end of the console cable to the **console** port on the left.
3. Connect the DB9 end of the console cable to a PC's COM port.
4. Connect a standard Ethernet cable (Cat5e or better) to the 10/100/1000 **Mgmt** port on the chassis.
5. Connect the other end of the Ethernet cable to an Ethernet network.

Configuring Basic GigaVUE H Series H Series Settings

This section describes how to perform the initial configuration of basic GigaVUE H Series H Series node settings over a serial terminal connection to the console port.

The system administrator must initially log in with a default **admin** account using a default password, and then must immediately change the password through the **jump-start** script. Refer to [Access the Command-Line Interface over the Console Port](#).

Once you have used the console port to configure the Mgmt port's network properties, you can configure the GigaVUE H Series H Series node remotely using the Mgmt port's network connection.

The same commands are available in the GigaVUE-OS command-line interface regardless of whether you are connected over the Mgmt or console port.

Access the Command-Line Interface over the Console Port

Access to the control card is through the console port on the left side on the front of the GigaVUE-HC2.

1. Make the basic power and console cable connections described in [Connecting Serial Console and Mgmt Ports](#) and power on GigaVUE-HC2.
2. Start a terminal application on the PC. Common terminal applications include TeraTerm, PuTTY, and Hyperterminal.
3. Select the COM port connected to the console cable attached to control module. For example, **COM1**.
4. Configure the port settings for the console connection as follows:
 - o **Bits per second** – 115,200
 - o **Data bits** – 8
 - o **Parity** – None
 - o **Stop bits** – 1
 - o **Flow control** – None

NOTE: You can change the console port's speed if you need to by using the procedure in [Changing the Console Port's Speed](#).

NOTE: If you experience problems connecting to a Cisco Terminal Server, try changing the console port's speed to 9600 bps using the procedure in [Changing the Console Port's Speed](#) and reconnecting.

[Figure 7 Setting COM Port Properties for the Console Connection](#) shows an example of how these settings are configured in Hyperterminal.

Figure 7 *Setting COM Port Properties for the Console Connection*

5. Start the terminal connection. You may need to press **Enter** a few times before you see the **login:** prompt.
6. Log in to the command-line interface with the following default user account and password:

User:admin

Password:admin123A!

The **configuration jump-start** automatically starts and forces a password change.

The system administrator must change the password on the default **admin** account through the **jump-start** script. The default password (admin123A!) is no longer allowed. Refer to [Run the Jump-Start Script](#) for details.

A password must meet the following standards:

- include 8-64 characters
- include at least one numeral
- include at least one upper case letter
- include at least one lower case letter
- include at least one special character (for example, !, @, #, \$, %, ^, &, or * – ASCII 0x21, 0x2F, 0x3A, 0x40, 0x5B, 0x5F, 0x7B, 0x7E)
- Must not include the user name or parts of full-name.

At the Admin password? prompt in the **jump-start** script, enter a new password that meets the standards, then confirm the password.

You will also configure some Admin and Monitor level users with the procedure described in [Initial User Account Configuration](#).

Changing the Console Port's Speed

You can change the console port's speed using the following procedure:

1. Establish a serial console connection to the console port.
2. Reboot the node with the **reload** command.
3. Watch for the **Press Enter to boot this image, or any other key for boot menu** message. When it appears, press any key **except** Enter to access the Boot Menu.
4. When the Boot Menu appears, press the **C** key to enter command prompt mode.
5. Use the following command to change the baud rate:

```
=>setenv baudrate <baudrate>.
```

6. Save your changes with the following command:

```
=>saveenv
```

7. Reboot the node with the following command:

```
=>boot
```

8. Remember to set the baud rate for your terminal server to the same **<baudrate>** you specified in this procedure.

Run the Jump-Start Script

Gigamon provides GigaVUE H Series H Series nodes with a **jump-start** script that walks you through the process of configuring basic settings. Run this script as follows:

1. Switch to **Configure** mode.

The GigaVUE H Series provides three command entry modes, each with increasingly powerful rights – **Standard**, **Enable**, and **Configure**. The jump-start script is only available in Configure mode:

- a. Type **en <Enter>** to switch to Enable mode.

The system prompt changes from **[hostname] >** to **[hostname] #**.

- b. Type **config t <Enter>** to switch to Configure mode.

The system prompt changes from **[hostname] #** to **[hostname] (config) #**.

2. Run the jump-start script with the following command:

(config) # config jump-start

3. Follow the jump-start script's prompts to configure each of the settings listed in the following table.

NOTE: If you change your mind about a particular setting, you will have a chance to change it at the end of the script.

Hostname	The hostname appears in the system prompt and is used to identify the chassis in SNMP traps.
Management Port Network Settings	Use either DHCP or specify a static IP address and netmask. If you do not use DHCP, you are prompted to configure the following additional options: <ul style="list-style-type: none"> ■ Default Gateway Supply the IP address of the default gateway for the node. ■ DNS Server Supply the IP address of the DNS server for the node. A valid DNS server is required for successful use of TACACS+. ■ Domain Name Supply the domain name for the node (for example, mycompany.com).
Enable IPv6?	You can enable the use of IPv6 for the management port. IPv6 is used in addition to IPv4 if you enable this option. If you enable the IPv6 you have the option of enabling IPv6 auto-configuration or specifying a static address.
Security Settings	Enable the following security settings: <ul style="list-style-type: none"> ■ secure cryptography mode ■ secure passwords mode ■ minimum password length Refer to the GigaVUE-OS CLI Reference Guide for information on security.
Admin Password	The password for the admin account must be changed to a non-default password.

Cluster Enable?	<p>Enable cluster support if this node will be a part of a cluster of connected GigaVUE H Series nodes. If you enable cluster support, the jump-start script prompts you to supply the Cluster ID, Cluster Name, and Cluster Mgmt Virtual IP Address. You can join an existing cluster by supplying values that match existing settings.</p> <div data-bbox="623 331 1471 516" style="border: 1px solid #ccc; padding: 5px;"> <p>NOTE: For clustered nodes configured to use the eth1 port on a control card as both the Mgmt and Cluster Management port, keep in mind that NTP is also used over the eth0 Mgmt port on the GigaVUE H Series H Series node. In a case like this, you can only use one or the other.</p> </div> <p>If clustering is enabled, you will not be prompted for a box ID in the next step.</p> <p>Refer to the <i>GigaVUE-OS CLI Reference Guide</i> for information on setting up a cluster.</p>
Box ID for the Node	<p>Supply a numerical box ID for the node. This box ID is used to identify network/tool ports in the node – the format is box ID/ slot ID/port ID. You will be prompted for a box ID only if clustering was not enabled in the previous step.</p>

4. Review your settings. You can change a setting by specifying its listed line number and re-entering the setting.
5. When you are satisfied with your settings, exit the script as prompted. GigaVUE H Series automatically saves your settings.
6. Restart the node with the **reload** command.

Need to Change Any Settings?

If you need to change any of the settings you made in the jump-start script, you can either run the script again or change individual settings using the following commands in the Configure command mode:

- Use the **hostname** command to change the node's hostname.
- Use the **interface eth0** command to reconfigure or fine-tune Mgmt port settings, including basic IP settings (DHCP or static address and subnet mask) and physical parameters (duplex, MTU, and speed).
- Use the **ip** command to change the default gateway, DNS server, and domain name.
- You can also use the **username admin password <password>** command to change the **admin** user's password. Refer to [Changing the admin Account Password](#).

Refer to [The Basic Commands on page 49](#) for a quick summary of the available GigaVUE H Series H Series commands.

Configure Modules and Enable Ports

Modules must be configured and ports enabled before they can be used on the GigaVUE-HC2. Use the following procedure to bring up all modules and enable ports before starting to issue commands in the CLI:

1. Connect to console port as described in the previous section.
2. Wait at least two minutes after the system prompt appears for the modules to be initialized and then switch to **Configure** mode. The GigaVUE H Series H Series provides three command entry modes, each with increasingly powerful rights – **Standard**, **Enable**, and **Configure**. The jump-start script is only available in Configure mode:
 - a. Type **en <Enter>** to switch to Enable mode.
The system prompt changes from **[hostname] >** to **[hostname] #**.
 - b. Type **config t <Enter>** to switch to Configure mode.
The system prompt changes from **[hostname] #** to **[hostname] (config) #**.
3. Reset the terminal settings to match the current window with the following command:

(Config) # terminal resize

 1. Use the following command to check module status:

(Config) # show cards
4. Verify the following in the **show cards** output:
 - o **Box ID** is not empty.
 - o **Config** shows **yes** for all cards.
 - o **Oper Status** shows **up** (or **inserted**) for all modules.
5. If **Config** does not show **yes** for all modules after two minutes, take the action corresponding to your **show cards** output, as follows:

show cards Output:	Corrective Action
Config does not show yes for any modules (including control cards)	(config) # chassis box-id <integer> (config) # card all
Config shows yes for control cards but not one or more modules	(config) # card all

The **card all** command configures the node for all currently unconfigured modules. However, it can only be used after the node's box ID has been configured as reported at the top of the **show cards** output in [Figure 8Successful show cards Output](#).

6. Use the **show cards** command again to verify the following:
 - o **Box ID** is not empty.
 - o **Config** shows **yes** for all modules.
 - o **Oper Status** shows **up** (or **inserted**) for all modules.

[Figure 8Successful show cards Output](#) illustrates the **show cards** output for a GigaVUE-HC2 with properly configured modules.



Figure 9 GigaVUE-OS Command-Line Modes

NOTE: If you are working simultaneously with multiple GigaVUE H Series nodes, you may want to assign each a separate hostname so its easy to identify separate terminal sessions from the system prompt. Admin users can do this in **Configure** mode with the **hostname <name>** command; refer to [Configuring the GigaVUE H Series H Series Host Name](#).

Entering Commands in the CLI

The GigaVUE-OS provides several conventions that make it easy to identify available commands and enter them quickly:

Technique	Description
<p>Context-Sensitive Help</p>	<p>The ? symbol is the key to receiving help wherever you are in the CLI:</p> <ul style="list-style-type: none"> Type ? by itself to see a list of all available commands. Word Help – Type a partial word with ? mark immediately following the partially-typed word to see a list of all possible commands using the word entered so far. <p>For example, if you typed r? in Configure mode, the CLI would return the following possible commands based on what you have entered so far:</p> <p>radius-server Configure RADIUS server settingsreload Reboot or shut down the systemreset Reset this system to its factory state</p> <ul style="list-style-type: none"> Command Help – Type a command followed by a question mark to see all possible arguments for the command as entered. If the node returns <cr>, that means the command can be entered as-is. <p>For example, if you entered gigastream ?, you would see alias. You can build your way through the entire command tree by entering ? after each new argument. For example, after entering gigastream alias myalias ?, you would see the next valid argument – port-list.</p> <div style="border: 1px solid black; padding: 5px; margin-top: 10px;"> <p>NOTE: Typing ? accesses the help system immediately – you do not need to press <Enter>.</p> </div>
<p>Partial Command Entry</p>	<p>For all GigaVUE H Series H Series commands and arguments, you only need to enter enough characters to distinguish the command from all other available commands. So, for example, you do not have to enter the full command debug – there is only one command starting with the letter d, so you only have to enter d.</p>
<p>Command Completion</p>	<p>If you have partially typed a command, you can press Tab and the CLI will attempt to complete the command for you based on what has been entered so far.</p> <p>Use the command completion feature together with partial command entry – you can press Tab while entering a command to see a list of all available commands matching what you have entered so far. For example, you can press p<Tab> and the node will return:</p> <p>ping ping6 port port-group port-pair ptp</p> <p>Based on this information, you know that you only need to enter pt to distinguish the ptp command from the other commands beginning with the letter p.</p>

Command-Line Syntax – Entering Commands

You enter all configuration commands for the GigaVUE-OS in the command-line interface. Enter commands by typing enough characters to uniquely identify the command and pressing **<Enter>**.

When entering commands, keep in mind the following rules:

- Successful commands return no response in the CLI; commands with errors return an error response beginning with **%**, followed by a short error description.
- All commands are case-sensitive.
- Aliases are case-sensitive and accept both lower and upper case – for example, **my_alias** and **My_Alias** refer to two separate maps.
- The **no** command is used to remove configuration settings. For example **no connect alias myconnect** deletes the named **myconnect**.
- Port numbers are entered in **<chassis-id>/<slot-num>/<port-num>** format. For example, **1/1/x1** identifies the 10Gb/1Gb port x1 in slot 1 on box 1.
- Strings must consist entirely of alphanumeric characters with no spaces. The only exceptions are the underscore (**_**) and hyphen (**-**) characters. Those are allowed.

For example, in Configure mode, **port 1/1/g1 alias My_Alias** is legal, but **port 1/1/g1 alias My Alias** is not.

NOTE: Some string fields do accept spaces provided the input is made inside quotation marks (for example, the **banner login** command described in [Using a Custom Banner](#)).

Configure Mode Syntax

Users of GigaVUE H Series nodes may be accustomed to entering the word **config** before many commands – **config map**, **config port-filter**, and so on. When using the GigaVUE-OS, the “config” part of the command is implied whenever you are working in Configure mode. The system prompt helps you remember this by including the word **(config)** in parentheses. For example:

(config) #

So, instead of entering **config gigastream** to set up a GigaStream consisting of multiple ports, you just enter **gigastream** followed by the necessary arguments. The **config** part is implied because you are already working in the Configure mode. For example:

(config) # gigastream alias mystream port-list 1/1/x1..x4

Paging through CLI Output

By default, the CLI returns output exceeding the configured terminal length in pages. The CLI provides the same features for working through the paged output as the Linux programs **less** and **more**. Press the **h** key when presented with the paging prompt at the base of the display to see paging options – [Figure 10 Viewing Paging Options](#) provides an example of how to do this.

If you prefer, you can disable paging either for the current session or by default:

- **Disable for Current Session(config) # no cli session paging enable**
- **Disable for All Sessions (Default)(config) # no cli default paging enable**

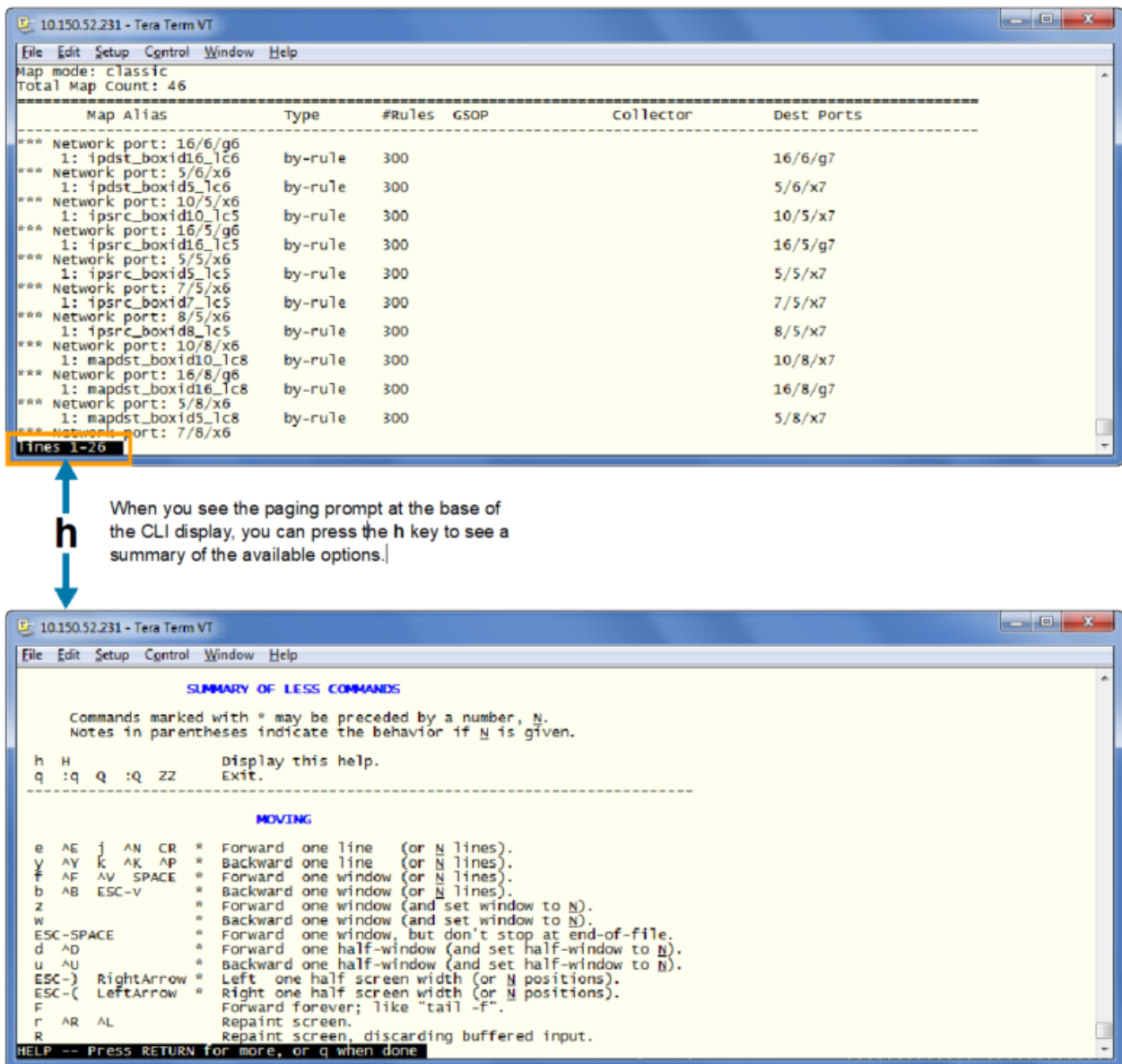

Figure 10 Viewing Paging Options

The Basic Commands

The following table lists each of the top level commands for the GigaVUE-OS in Configure mode. As described in [Entering Commands in the CLI](#), the commands available in Configure mode are a superset of those available in Standard and Enable modes. Most commands have multiple supported arguments. You can see the exact arguments available at any point of command entry by typing it into the CLI followed by **?**.

Table 1: CLI Commands

Command	Description
aaa	Configures authentication, authorization, and accounting settings
apps	Enables access to Gigamon Applications, such as Application Session Filtering (ASF), GTP backup, GTP whitelisting, inline SSL decryption, keystore, NetFlow, SIP whitelisting, and Passive SSL decryption. GigaSMART applications are not supported on GigaVUE TA Series.
banner	Sets a node login banner.
bond	Configures bonded interface settings.
boot	Configures node boot parameters.
card	Configures a line card or module.
chassis	Configures the GigaVUE H Series H Series chassis.
clear	Resets statistics or clears caches.
cli	Configures CLI shell options.
clock	Sets the node clock or timezone.
cluster	Configures a cluster of connected GigaVUE-OS nodes.
configuration	Manages configuration files.
configure	Enters Configure mode.
coreboot	Upgrades the BIOS image on GigaVUE H Series-TA100 and GigaVUE-HC1.
crypto	Manages X.509 certificates for the GigaVUE H Series H Series node's Web server.
debug	Generates a dump file for use in debugging issues with Gigamon Technical Support.
disable	Exits Enable mode and returns to Standard mode.
email	Configures email and event notification via email.
enable	Enters Enable mode.
exit	Exits Configure mode and returns to Enable mode or logs out of the CLI.
file	Manages TCP and debug dump files on disk.
filter-template	Configures flexible filter templates on GigaVUE-HC3 and GigaVUE H Series-TA100.
gigasmart	Configures an interface address to a GigaSMART card or module.
gigastream	Configures a GigaStream—a group of ports acting as a single addressable tool port destination or stack-link.
gsgroup	Configures a GigaSMART group consisting of one or more internal GigaSMART ports.

Command	Description
<i>gsop</i>	Configures a GigaSMART operation consisting of one or more advanced processing applications.
<i>gsparams</i>	Configures GigaSMART parameters.
<i>halt</i>	Shuts down the node without powering it off.
<i>hb-profile</i>	Configures a heartbeat profile on GigaVUE H Series HC Series nodes.
<i>help</i>	Views a description of the interactive help system.
<i>hostname</i>	Specifies the node's hostname. The hostname appears in the system prompt and in SNMP traps.
<i>ib-pathway</i>	Reserved for future use.
<i>image</i>	Manages node software images.
<i>inline-network</i>	Configures an inline network on GigaVUE H Series HC Series nodes.
<i>inline-network-group</i>	Configures an inline network group on GigaVUE H Series HC Series nodes.
<i>inline-serial</i>	Configures an inline tool series on GigaVUE H Series HC Series nodes.
<i>inline-tool</i>	Configures an inline tool on GigaVUE H Series HC Series nodes.
<i>inline-tool-group</i>	Configures an inline tool group on GigaVUE H Series HC Series nodes.
<i>interface</i>	Configures network interfaces.
<i>ip</i>	Configures IP settings for the eth0 Mgmt port.
<i>ipv6</i>	Configures IPv6 settings for the eth0 Mgmt port.
<i>job</i>	Configures scheduled jobs.
<i>ldap</i>	Configures LDAP server settings for authentication.
<i>license</i>	Activates features using license keys. Licensing is used for GigaSMART, Port, or Advanced Features License.
<i>logging</i>	Configures event logging.
<i>map</i>	Configures maps and map rules to manage GigaVUE H Series traffic distribution.
<i>map-group</i>	Configures map groups for GTP whitelisting and GTP flow sampling.
<i>map-passall</i>	Creates a pass-all map to send all traffic on a network port to a tool port irrespective of the other packet distribution in place on the port.
<i>map-collector</i>	Configures shared collector map parameters.
<i>map-template</i>	Configures a map template.
<i>nhb-profile</i>	Configures a negative heartbeat on GigaVUE H Series HC Series nodes.

Command	Description
<i>no</i>	Deletes or clears certain configuration options.
<i>notifications</i>	Configures notification settings.
<i>ntp</i>	Enables and disables the use of NTP, as well as adds NTP servers.
<i>ntpdate</i>	Sets node clock once from a remote server using NTP.
<i>ping</i>	Sends ICMP echo requests to a specified host.
<i>ping6</i>	Sends IPMPv6 echo requests to a specified IPv6 host.
<i>pld</i>	Upgrades programmable logic devices (PLDs) on GigaVUE-HC3 nodes.
<i>policy</i>	Configures an active visibility policy.
<i>port</i>	Configures port type, parameters, and filters.
<i>port-group</i>	Creates a group of ports.
<i>port-pair</i>	Configures a port-pair on a pair of network ports within the same GigaVUE H Series H Series node. A port-pair is a bidirectional connection in which traffic arriving on one port in the pair is transmitted out the other (and vice-versa) as a pass-through TAP.
<i>ptp</i>	Enables and disables the use of PTP.
<i>radius-server</i>	Configures RADIUS server settings for authentication.
<i>redundancy-profile</i>	Configures an inline redundancy profile on GigaVUE H Series HC Series nodes.
<i>reload (reboot)</i>	Reboots or shuts down the node.
<i>reset</i>	Resets specified portions of the node configuration to their factory states.
<i>serial</i>	Sets options for the serial console port.
<i>sfp</i>	Reserved for future use.
<i>show</i>	Displays configuration and status information for GigaVUE H Series H Series settings and entities.
<i>sleep</i>	Sleeps for a specified number of seconds.
<i>snmp-server</i>	Configures SNMP settings, including the local SNMP server, notification events, and notification destinations.
<i>spine-link</i>	Configures spine links in a cluster with a leaf and spine architecture.
<i>ssh</i>	Enables and disables SSH access, as well as manages settings.
<i>stack-link</i>	Configures a stack-link between two GigaVUE H Series H Series nodes in a cluster. Stack-links are used to carry data traffic between nodes in a GigaVUE H Series H Series cluster.
<i>sync</i>	Enables dynamic control card synchronization for a GigaVUE H Series-HD8 node.

Command	Description
<i>system</i>	Changes system settings.
<i>system-health</i>	Configures system health behaviors.
<i>tacacs-server</i>	Configures TACACS+ server settings for authentication.
<i>terminal</i>	Sets terminal parameters, including width and length.
<i>timestamp</i>	Configures the timestamp source.
<i>tool-mirror</i>	Configures a tool-mirror connection between two tool ports. A tool-mirror connection sends all packets arriving on one tool port to a second tool port on the same node.
<i>traceroute</i>	Traces the route packets take to a destination.
<i>tunnel</i>	Reserved for future use.
<i>tunnel-endpoint</i>	Configures a tunnel endpoint, which is a destination for load balanced traffic from a L2GRE encapsulation tunnel.
<i>tunneled-port</i>	Configures a tunnel port to be used for GigaSMART encapsulation/decapsulation operations.
<i>uboot</i>	Installs new uboot software.
<i>username</i>	Manages user accounts.
<i>vport</i>	Configures a virtual port.
<i>web</i>	Configures the Web server used for H-VUE GUI support on the GigaVUE H Series H Series node.
<i>write</i>	Saves the running configuration to persistent storage.

Completing the Initial GigaVUE H Series H Series Setup

At this point, you have logged in to the GigaVUE-OS command-line interface using the **admin** account, configured the **Mgmt** port's network properties for SSH access, and have explored the command-line interface structure.

There are a few more steps you should perform to complete the initial configuration before you get to the fun stuff – setting up network ports, tool ports, and mapping traffic. These tasks include:

- Switch to the Configure mode. Refer to [Enter the Configure Command-Line Mode](#).
- Configure SSH access to the node. Refer to [SSH2](#).
- Enable the GigaVUE H Series Web server for Web-based GUI access. Refer to [Enabling the GigaVUE H Series Web Server](#).
- Configure some basic user accounts. Refer to [Initial User Account Configuration](#).
- Configure the GigaVUE H Series name. Refer to [Configuring the GigaVUE H Series H Series Host Name](#).

- Configure the GigaVUE H Series time and date options. Refer to [Configuring GigaVUE H Series H Series Time Options](#).
- Configure automatic email notifications for node events. Refer to [Configuring Automatic Email Notifications](#).
- Configure a custom login banner. Refer to [Using a Custom Banner](#).
- Save your changes! Refer to [Saving Changes](#).

Enter the Configure Command-Line Mode

Keep in mind that the GigaVUE-OS has three different command modes for the CLI – **Standard**, **Enable**, and **Configure**. The commands described in the following sections are all only available in Configure mode. Switch to Configure mode as follows:

Command	Notes
> enable	You only need to supply enough of each command to positively identify it among the other available commands. So, in this example, you could just type ena and press Enter.
# configure terminal	Similarly, this command can be entered as co t .
(config) #	Notice how the system prompt changes with each command mode. Command modes offer greater control over the node as you ascend from Standard to Enable to Configure .

SSH2

SSH2 is available for remote connections to the GigaVUE-HC2's **Mgmt** port. By default, SSH2 is enabled. Use the **ssh** commands in Configure mode to enable or disable the corresponding connections. To disable the corresponding connection, you include **no** before the command, as demonstrated in the following table. For example:

Command	Notes
Enable: (config) # ssh server enable Disable: (config) # no ssh server enable	<p>When SSH2 is enabled, use any compliant SSH2 client to connect to the command-line interface remotely. For example, to connect using the popular SSH2 client, PuTTY:</p> <ol style="list-style-type: none"> Start PuTTY and enter the GigaVUE H Series H Series node's IP address in the Host Name field. Click the SSH protocol radio button. Click Open to open a connection. <p>If this is your first connection PuTTY warns you that the host key presented by the GigaVUE H Series H Series node is not in your cache. You can add the key, connect without adding the key, or cancel the connection. Refer to Verifying Host Keys During Connection for information on how to verify that the host key shown is the correct one.</p> <ol style="list-style-type: none"> Log in with GigaVUE H Series credentials.

Advantages of SSH2

SSH2 is a secure choice for remote connections, providing an encrypted channel instead of relying on clear text. It also provides stronger user authentication capabilities, including the use of a public **host key**. Host keys uniquely identify a server, helping guarantee that the server you are connecting to is the server you think it is.

GigaVUE H Series includes default RSA v1/v2 and DSAv2-encrypted public host keys (SSH2 supports both RSA and DSA encryption algorithms). The first time you connect to GigaVUE H Series with an SSH2 client, the client will warn you that the host keys are not in your local cache and show you the actual host key presented by the GigaVUE-HC2. Your client will most likely give you the option of trusting the key, adding it to your local cache. Once you have trusted the key, your client will alert you during connection if a different key is presented.

IMPORTANT: Telnet server functionality is no longer supported as of GigaVUE-OS 5.7.00.

Verifying Host Keys During Connection

To verify that the host key presented during an SSH2 connection is in fact the GigaVUE H Series node's, you can connect over the console port (refer to [Access the Command-Line Interface over the Console Port](#) and use the **show ssh server host-keys** command to see the current public host keys and fingerprints for the GigaVUE-HC2. Paste these in a file and keep them nearby when you connect via SSH2 the first time. This way, you will be able to compare the actual host key to what your SSH2 client says is being presented. Once you have verified that they are the same, you can choose to trust the host key, allowing future connections to take place seamlessly.

Changing Host Keys

Use the **ssh server host-key generate** command to change the default host keys provided with the GigaVUE-HC2. The command has the following syntax:

```
ssh server host-key <rsa1 | rsa2 | dsa2> <private-key | public-key> generate
```

For example, to configure a new RSAv1 public hostkey, you could use the following command:

```
(config) # ssh server host-key rsa1 public-key generate
```

Initial User Account Configuration

Before you start mapping traffic, you must change the password for the **admin** account and add a few other accounts for use by different level users. (You may have already used the jump-start script to change the password for the **admin** account.)

Changing the admin Account Password

1. To change the password for the **admin** account using the **username** command, refer to the following:

```
(config) # username admin password <password>
```

Passwords must meet the following standards:

- o Include 8-64 characters.
- o Include at least one numeral
- o Include at least one capital letter
- o Include at least one special character (for example, **!**, **@**, **#**, **\$**, **%**, **^**, **&**, or ***** – ASCII 0x21, 0x2F, 0x3A, 0x40, 0x5B, 0x5F, 0x7B, 0x7E).

Enter a new password that meets the standards and confirm the password.

Setting Up Some Basic Accounts

1. Next, you will probably want to set a few user accounts with different access levels.

The GigaVUE H Series H Series node has a local account database that can optionally integrate with an LDAP, RADIUS, or TACACS+ server for authentication. Any account you want to authenticate using an external AAA server must have a matching account name in the local database.

Authentication, user levels, and roles are discussed in detail in the **GigaVUE-OS CLI Reference Guide**. For now, however, it is easiest to simply create a few basic user accounts with different privilege levels. In general, user privileges are as follows:

- o **Admin** users have access to all command modes, including Standard, Enable, and Configure. They also have full permissions for all network, tool, and stack ports.
- o **Operator** users have access to all command modes, including Standard, Enable, and Configure. However, they only have access to the network and tool ports associated with their user group.

New users are created with the operator role by default. You can add additional roles with the **username <username> roles add <roles>** command.

- o **Monitor** users have access to the Standard and Enable command modes. They cannot configure packet distribution (or any other global GigaVUE H Series H Series node options), but they can use the **show** command to review many of the settings in place on the node.

The following **username** commands create a new **admin** user and a new **operator** user:

Command	Comments
<pre>(config) # username psandoval password Nine9.Eight8! (config) # username psandoval roles add admin</pre>	Creates a new account named psandoval with a password, and grants it admin privileges.
<pre>(config) # username bcrawford password Seven7.Six6!</pre>	Creates a new account named bcrawford with a password. New users are automatically created with default operator level privileges, so there is no need to grant an additional role.

2. Once you have configured these basic user accounts, use the **show usernames** and **show roles** commands to review your settings.

Configuring the GigaVUE H Series H Series Host Name

It is generally a good idea to configure the GigaVUE H Series H Series node's name, date, and time as part of your initial configuration. The following command shows how to set the node name. Refer to [Configuring GigaVUE H Series H Series Time Options](#) for information on setting options related to time and date.

Setting the Node Name

1. Use the **hostname** command to specify the node name. For example:

```
(config) # hostname GigaVUE H Series-QA
```

Configuring GigaVUE H Series H Series Time Options

The GigaVUE H Series H Series node includes a variety of features for setting the time, including:

Method	CLI Command	For more information:
System Clock	clock set hh:mm:ss yyyy/mm/dd	Setting Time Manually on page 59
One-Time NTP Synchronization	ntpdate <ntpserver address>	Performing One-Time NTP Server Synchronization on page 60
Persistent NTP Synchronization	Add server using ntp server command. Enable use of ntp with ntp enable command.	Using NTP Time Server for Clock Synchronization on page 60
PTP Synchronization	Enable PTP with ptp enable command.	GigaVUE-OS CLI Reference Guide

Setting Time Manually

The easiest way to set the GigaVUE H Series H Series node's time is manually with the **clock set** command. For example:

```
(config) # clock set 05:18:38 2015/01/06
```

NOTE: Even if you are using NTP, configure time manually as well. The GigaVUE H Series H Series node will automatically fall back to the manual time setting if it is unable to synchronize with the specified time server.

The **show ntp** will show the current state of the NTP server in use; the **show clock** command shows the current GigaVUE H Series H Series node's time.

Performing One-Time NTP Server Synchronization

You can perform a one-time synchronization with an NTP server using the **ntpdate** command. For example:

```
(config) # ntpdate time.nist.gov
```

NOTE: This method does not provide updates to correct clock drift over time. It is generally preferable to use persistent NTP synchronization with the **ntp** commands.

Using NTP Time Server for Clock Synchronization

The GigaVUE H Series H Series node can optionally use one or more NTP servers for its time setting. Use the following procedure to add an NTP server to the GigaVUE H Series H Series node's list and enable the use of NTP.

1. Specify the address of the time server. For example, if the time server is on 192.168.1.10, you would use the following command:

```
(config) # ntp server 192.168.1.10
```

NOTE: There are many public NTP servers available on the Internet.

2. Turn on NTP with the following command:

```
(config) # ntp enable
```

3. The GigaVUE H Series H Series node connects to the specified NTP server and synchronizes to its time.

4. NTP reports times in UTC. Because of this, it is a good idea to specify the GigaVUE H Series H Series node's timezone so that UTC can be converted to the local timezone.

You specify the timezone either in terms of the offset from UTC (either plus or minus) or with a particular location's name, depending on the argument you choose for the **clock timezone** command:

- o **Offset from UTC** – Set the timezone as an offset from UTC with the **UTC-offset** argument. For example, the following command sets the timezone as eight hours earlier than UTC:

```
(config) # clock UTC-offset UTC-8
```

- o **Location** – You can specify a particular location's timezone to use. The easiest way to do this is to build the available list of cities by adding a space and a question mark after each subsequent zone word. For example, enter **(config) # clock timezone ?** to see the list of available locations. Select a location and use the same question mark technique to see the next available zone words. This way, you can build out to the exact location you need. For example:

```
(config) # clock timezone America North United_States Pacific
(config) # clock timezone Asia Eastern Hong_Kong
```

Once you have finished configuring NTP options, use the **show ntp** command to check the status of clock synchronization ([Figure 11Checking NTP Status and Configuration](#)).

```

GigavUE (config) # show ntp
NTP is enabled.
Clock is synchronized. Reference: 69.25.96.13. Offset: -4.846 ms.
Active servers and peers:
-----
Address          Status      Stratum    Offset    Ref       Poll      Last
(msec)          (sec)      Clock
-----
69.25.96.13     sys_peer  (*)       1         -4.846    .ACTS.    64      24
GigavUE (config) #

```

Figure 11 Checking NTP Status and Configuration

Configuring Automatic Email Notifications

The GigaVUE H Series H Series node provides powerful email notification capabilities, automatically sending emails to specified addresses when any of a wide variety of events take place on the node. Gigamon strongly recommends that you configure this feature so you have immediate visibility of events affecting node health.

You configure automatic email notifications with the **email** command and its arguments. Start by making sure the CLI is in Configure mode. If the **(config)** entry appears in the system prompt, you are in Configure mode. If not, use the **enable** and **configure terminal** commands sequentially to change to Configure mode. Then, configure email notifications as follows:

Description	Command
First, use the email mailhub command to specify the mail server to use for notification emails. In this example, we are using the email server named smtp.emailsrvr.com . You could also supply an IP address instead of a hostname.	(config) # email mailhub smtp.emailsrvr.com
Next, use the email auth command to supply the email account username and password. In this example, we are using alerts@mycompany.com with a password of mypassword123 .	(config) # email auth username alerts@mycompany.com (config) # email auth password mypassword123
Now that we have set up the account to use, we will turn on email authentication.	(config) # email auth enable
Now that we have configured the settings that let the node send emails, set up who to send them to and when to send them. Use email notify recipient to configure the destinations for event notification emails. You can specify multiple destinations separated by commas with no spaces.	(config) # email notify recipient cday@mycompany.com,mfelton@mycompany.com
The email notify event command lets you configure which events will trigger automatic emails. There are quite a few events available	(config) # email notify event all

Description	Command
<p>– start by entering email notify event ? to see the list of available events. You can either enable individual events, or, use the all argument to enable them all. We are going to start with the all setting and tune settings as necessary later on.</p>	
<p>It is a good idea to check your settings and make sure emails are sent successfully. You can do that with the email send-test command. If you do not receive the email, check the show log output to make sure the email was sent. Then, reconfigure email settings, if necessary.</p>	<p>(config) # email send-test</p>
<p>You may also want to configure and enable autosupport emails. Autosupport emails are sent directly to Gigamon’s Technical Support department when specified events take place, enabling proactive problem resolution. The GigaVUE H Series H Series node is preconfigured with the correct destination address – you just need to enable the feature with the following command.</p> <p>Use show email events to see the list of events for which autosupport emails will be sent. You can change the list with the (no) email autosupport event command.</p>	<p>(config) email autosupport enable</p>
<p>Emails will now be sent automatically to the configured addresses when any of the selected events take place.</p> <p>There are many other options for fine-tuning automatic email settings, including how to handle “dead letters” (emails that did not reach their recipient), how the email address of the GigaVUE H Series H Series node should appear, the port for the email server, the reply-to address, and so on. Refer to the GigaVUE-OS CLI Reference Guide for details.</p>	

Using a Custom Banner

The GigaVUE H Series H Series node can display a customizable text banner at node startup before a user logs in. This way, users connecting to the node see the banner before they log in, giving them an idea of which node they are logging in to. The banner also appears after a user logs out.

Use the **banner login “<string>”** command to configure the login banner. For example:

```
(config) # banner login "Pacific Call Center"
```

NOTE: You only need to use quotation marks for the <string> if it includes spaces.

The next time you log in or out of the GigaVUE H Series H Series node, you will see the customizable banner.

Saving Changes

It is a good idea to use the **write memory** command to save changes as you make them. Later on, when you start setting up packet distribution with connections and maps, your changes will be added to the active configuration right away but will not be saved across a node reboot unless you use the **write memory** command to save your changes to flash.

NOTE: The name of the factory-provided configuration file is **initial**. You can see the name of the most recently booted configuration file by using the **show running-configuration** command (or **show configuration**) and look for the **## Running database** entry. In [Figure 12 Showing the Current Configuration File](#), you can tell that the GigaVUE H Series node is currently operating with the **initial** configuration file.

Refer to the **GigaVUE-OS CLI Reference Guide** for details on using configuration files.

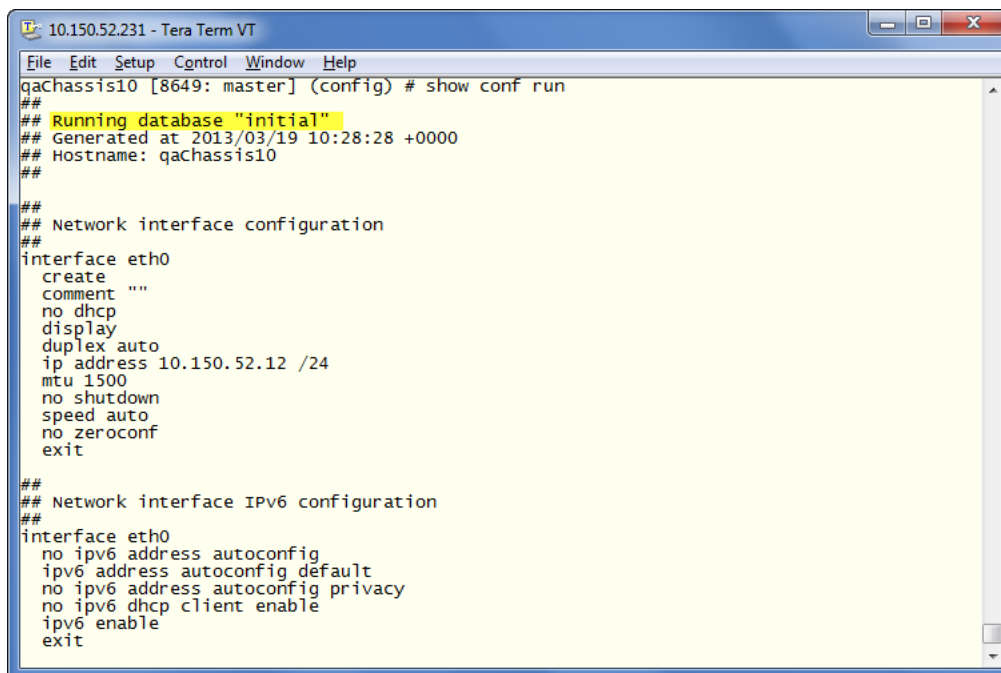

```

10.150.52.231 - Tera Term VT
File Edit Setup Control Window Help
qaChassis10 [8649: master] (config) # show conf run
##
## Running database "initial"
## Generated at 2013/03/19 10:28:28 +0000
## Hostname: qaChassis10
##
##
## Network interface configuration
##
interface eth0
  create
  comment ""
  no dhcp
  display
  duplex auto
  ip address 10.150.52.12 /24
  mtu 1500
  no shutdown
  speed auto
  no zeroconf
  exit
##
## Network interface IPv6 configuration
##
interface eth0
  no ipv6 address autoconfig
  ipv6 address autoconfig default
  no ipv6 address autoconfig privacy
  no ipv6 dhcp client enable
  ipv6 enable
  exit

```

Figure 12 Showing the Current Configuration File

Connecting GigaVUE-HC2 Ports

This chapter describes transceivers and port connections. In general, connecting GigaVUE-HC2 module ports to the network is as simple as installing a transceiver and connecting the correct cable to data sources or destinations. Refer to the following sections for details:

- [Transceiver—Rules and Notes](#)
- [BiDi Optics Considerations](#)
- [Transceiver Installation Instructions](#)
- [Fiber TAP Specifications](#)
- [Bypass Combo Module Specifications](#)
- [Cabling](#)
- [Connecting GigaVUE-HC2 Module Ports](#)

Transceiver—Rules and Notes

Keep in mind the following rules and notes when you connect and use GigaVUE-HC1 nodes with transceivers:

- Always use transceivers purchased from Gigamon to ensure interoperability and performance. Gigamon does not support transceivers purchased from other vendors.
- After removing an optical transceiver, the best practice is to wait seventeen (17) or more seconds before re-inserting the same or different optical transceiver. This includes the intervals between removal/insertion/re-insertion.
- Use the **show port params all** command to see transceiver type information for each of the network/tool ports in the GigaVUE-HC2 node. Check the value of the **SFP type** field for the ports in question.
- Following are the nomenclatures for the GigaVUE-HC2 node port numbers:
 - Port numbers starting with c (for example, c1) are 100Gb.
 - Port numbers starting with q (for example, q1) are 40Gb.
 - Port numbers starting with x (for example, x10) are 10Gb or 1Gb depending on the transceiver installed.
- For details about the supported transceivers, cable types, and connectivity specifications, refer to *“GigaVUE-OS Compatibility and Interoperability Matrix”*.

BiDi Optics Considerations

There are several nuances to consider due to the complexity in 40Gb BiDi technology. Because of the nature of 40Gb BiDi technology, the same BiDi optic (Full Duplex or RX-only) cannot be used in all of the following situations. For example:

- On SPAN sessions, RX-only BiDi optics cannot be used. Full Duplex BiDi optics must be used.
- When receiving traffic from network links, RX-only BiDi optics must be used due to the way traffic is multiplexed over the fiber pair in 40Gb BiDi technology.
- When deploying over inline 40Gb BiDi links, Full Duplex BiDi optics must be used.
- When connecting two GigaVUE H Series nodes through a cascade connection, Full Duplex BiDi optics must be used for the tool port. The network port may be either Full Duplex or RX-only BiDi optics.
- When stacking multiple GigaVUE H Series nodes, 40Gb BiDi optics must not be used on stack links because the 40Gb BiDi technology is not compatible with the Gigamon stack protocol.

Transceiver Installation Instructions

Gigamon transceivers are keyed and can only be installed in one direction. Transceivers are hot-swappable – they can be installed or removed with the power on or off. Use the following procedures to install and remove SFPs from GigaVUE H Series modules.

IMPORTANT: Always use an ESD-preventive wrist or ankle strap and ensure that it makes good skin contact when installing or removing SFP/SFP+ transceivers. The strap can be connected to one of the following:

- ESD wrist strap connector. The GigaVUE-HC2 chassis provides a connector at the front of the chassis for this purpose labeled **ESD GND PT**.
- Captive installation screws on an installed module or power supply.
- Any unpainted surface on the chassis.

Installing Transceivers

1. Remove the dust cap from the port and set it aside for future use.
2. Orient the transceiver with the opening in the module and insert it into the slot.
3. Push gently but firmly until the transceiver is seated in the slot.
4. Close the latch on the SFP to lock it into the slot.

Removing Transceivers

1. Disconnect the cable (if any) from the transceiver.
2. If you are removing a fiber-optic transceiver, install dust caps in the transceiver to protect the optical interfaces.
3. Open the latch on the transceiver and gently remove it from the slot.
4. If you are not installing a new transceiver, install a dust cap in the open slot on the module.

Fiber TAP Specifications

Refer to [Table 1: Internal Transceiver Specifications for Fiber TAPs](#) and the “*Transceiver and Cable Matrix for GigaVUE H Series-H Series Fiber TAP Modules*” section in the *GigaVUE-OS Compatibility and Interoperability Matrix* for specifications for Fiber TAPs, including internal transceiver specifications and loss summaries.

Table 1: Internal Transceiver Specifications for Fiber TAPs

Module Type	Transceiver Type	Speed	Auto Negotiation	Duplex
TAP-HC2-D25AC05X/SR 50/12512 TAP Module	N/A	10000Mbps (10Gbps)/1000Mbps (1Gbps)	Always OFF	Full
TAP-HC2-D25BC05X/SR 62.5/12512 TAP Module	N/A	10000Mbps (10Gbps)/1000Mbps (1Gbps)	Always OFF	Full
TAP-HC2-D35CC0LX/LR12 TAP Module	N/A	10000Mbps (10Gbps)/1000Mbps (1Gbps)	Always OFF	Full
TAP-HC2-G100C0Copper (RJ-45)12 TAP Module	N/A	1000Mbps (1Gbps)	Always ON	Full

Bypass Combo Module Specifications

Refer to [Table 2: Internal Transceiver Specifications for Bypass Combo Modules](#) and [Table 3: Loss Summary per Bypass Combo Modules](#) for specifications for bypass combo modules, including internal transceiver specifications and loss summaries.

Table 2: Internal Transceiver Specifications for Bypass Combo Modules

Module Type	Transceiver Type	Speed	Auto Negotiation	Duplex
BPS-HC0-D25A4GSX/SR 50/125Bypass Combo Module	SFP+ 1Gb/10Gb Dual Rate 850nm MM	10000Mbps (10Gbps)/1000Mbps (1Gbps)	Always OFF	Full
BPS-HC0-D25B4GSX/SR 62.5/125Bypass Combo Module	SFP+ 1Gb/10Gb Dual Rate 850nm MM	10000Mbps (10Gbps)/1000Mbps (1Gbps)	Always OFF	Full

Module Type	Transceiver Type	Speed	Auto Negotiation	Duplex
BPS-HC0-D35C4GLX/LRBypass Combo Module	SFP+ 1Gb/10Gb Dual Rate 1310nm SM	10000Mbps (10Gbps)/1000Mbps (1Gbps)	Always OFF	Full
BPS-HC0-Q25A28SR4 50/125Bypass Combo Module	QSFP+ 40Gb Single Rate 850nm MM	40000Mbps (40 Gbps)	Always OFF	Full

Table 3: Loss Summary per Bypass Combo Modules

Type	@	Operating Wavelength (nm)			Cable Type	Max Fiber Length	Max Receiver Sensitivity	Insertion Loss (dB)
		Min	Typical	Max				
BPS-HC0-D25A4GSX/S R 50/125	1Gb	840	850	860	LC	550m	-17	2
	10Gb	840	850	860	LC	82m	-11.1	2
BPS-HC0-D25B4GSX/S R 62.5/125	1Gb	840	850	860	LC	275m	-17	2
	10Gb	840	850	860	LC	33m	-11.1	2
BPS-HC0-D35C4GLX/LR	1Gb	1260	1310	1355	LC	10km	-19	2
	10Gb	1260	1310	1355	LC	10km	-12.6	2
BPS-HC0-Q25A28SR4 50/125	40Gb	840	850	860	MPO/MTP	100m	-13	1

Module Transceiver Support

Refer to [Table 4: Transceiver Support for GigaVUE-HC2 Modules](#) for transceiver support for GigaVUE-HC2 modules.

Table 4: Transceiver Support for GigaVUE-HC2 Modules

Module Type	Transceiver Type	Speed	Auto Negotiation	Duplex
PRT-HC0-C02	QSFP28	100000Mbps (100Gbps)	Always OFF	Full

Cabling

Refer to the following section or documents for cabling:

- [MPO/MTP 12 Position Fiber Cable for Use with SR4 Transceivers](#)
- For details about the supported transceiver, cable type, and connectivity specifications, refer to “*GigaVUE-OS Compatibility and Interoperability Matrix*”.
- For details about how to cable GigaVUE H Series nodes, refer to “*GigaVUE-OS Cabling Quick Reference Guide*”.

MPO/MTP 12 Position Fiber Cable for Use with SR4 Transceivers

This is a female to female Multi-fiber Push On (MPO) / Ultra Polished Connector (UPC) of cable type B. The following figure provides cabling details for MPO/MTP 12 position fiber cable for use with 40Gb SR4 QSFP+, 40Gb ESR4 QSFP+, and 100Gb SR4 QSFP28 transceivers on GigaVUE-HC2 modules.

Connecting GigaVUE-HC2 Module Ports

Connecting network and tool ports on GigaVUE-HC2 modules is generally as simple as connecting a cable between the source/destination device and the GigaVUE-HC2 module port. You just need to make sure that the modules and ports on the GigaVUE-HC2 node are enabled and their parameters are configured correctly. Refer to the following sections for details:

- [Enabling Modules and Ports](#) – Make sure that the modules and ports you want to use are enabled. Newly installed modules must be configured with the **card** command and their ports enabled with **port <port-list> params admin enable**.
- [Setting Port Parameters Manually](#) – If both ends of the connection are using autonegotiation, no manual configuration is typically necessary. However, if autonegotiation is not used (or is not successful), you can use these instructions to configure port parameters manually.

Enabling Modules and Ports

Use the following procedure to ensure that all modules are configured and ports enabled:

1. Connect to console port as described in [Access the Command-Line Interface over the Console Port on page 69](#).
2. Wait at least two minutes after the system prompt appears and then switch to **Configure** mode.

The GigaVUE-HC2 node provides three command entry modes, each with increasingly powerful rights – **Standard**, **Enable**, and **Configure**. Module and port configuration commands are only available in Configure mode:

- a. Type **en <Enter>** to switch to Enable mode.

The system prompt changes from **[hostname] >** to **[hostname] #**.

- b. Type **config t <Enter>** to switch to Configure mode.

The system prompt changes from **[hostname] #** to **[hostname] (config) #**.

3. Use the following command to check module status:

(config) # show cards

4. Check the values in the **Config Status** and **Oper Status** columns for all modules and verify that they read **Yes** for configured and **Up** for inserted. This is your indication that the node is ready for further configuration.
5. If the **Config Status** does not show **Configured** for all modules after two minutes, take the action corresponding to your **show cards** output, as follows:

show cards Output:	Corrective Action
Config Status does not show Configured for any cards (including control cards)	(config) # chassis box-id <integer>(config) # card all
Config Status shows Configured for control cards but not one or more modules	(config) # card slot x <div style="border: 1px solid black; padding: 5px; margin-top: 10px;"> <p>NOTE: If all modules are unconfigured, you can also use the card all command. If some cards are already configured, however (for example, because you just installed a new card), it is better to use slot x for the unconfigured cards.</p> </div>

The **card** command initializes unconfigured module. However, it can only be used after the node's box ID has been configured, as reported at the top of the **show cards** output in [Figure 1 Successful show cards Output](#).

6. Use the **show cards** command again to verify the following:
 - o **Box ID** is not empty.
 - o **Config Status** shows **configured** for all modules.
 - o **Oper Status** shows **up** for all modules.

Figure 1 Successful show cards Output highlights the **show cards** output for a node with properly configured modules.

```
(config) # show cards box-id 1
```

Box ID: 1	Slot	Config	Oper Status	HW Type	Product Code	Serial Num	HW Rev
cc1	yes	up		HC2-Main-Board-v2	132-00C2	1AN0-0017	3.3-24
1	yes	up		BPS-HC0-D25B4G	132-00BF	1BF0-0036	2.0-1
2	yes	up		PRT-HC0-X24	132-00BD	1BD0-0064	A0-a2
3	yes	up		TAP-HC0-G100C0	132-00B3	1B30-0080	B0-a8
4	yes	up		PRT-HC0-X24	132-00BD	1BD0-0056	2.3-a2

Figure 1 Successful show cards Output

- Use the **port** command with the **admin** argument to enable the ports on the module. For example, the following two commands enable all ports on a PRT-HC0-X24 module:

```
(config) # port 1/1/x1..x24 params admin enable
```

- Save your changes so that the modules and ports come up automatically at the next reboot:

```
(config) # write memory
```

Setting Port Parameters Manually

If autonegotiation is not enabled on the other end of the connection, you must manually configure the **port params** of the GigaVUE-HC2 module port to match, followed by a **write** to save the current settings.

The **port params** commands are available in the Configure mode. The syntax is as follows:

```
port <port-list> params admin <disable | enable> autoneg <disable |
enable> discovery <cdp | lldp | all | disable> duplex
<full> forcelinkup <disable | enable> speed <10 | 100 | 1000 | 10000>
```

The following table summarizes these options:

Argument	Description
admin <disable enable>	Enables/disables ports administratively. Use the show port params command to see which ports are enabled and disabled. Refer to Forcelinkup and Enabling/Disabling Ports on page 80 for a summary of how this argument interacts with the admin argument.
autoneg <disable enable>	Enables and disables autonegotiation for a port. When autonegotiation is enabled, duplex and speed settings are ignored (they are set via autonegotiation). Refer to Forcelinkup and Enabling/Disabling Ports on page 80 for a summary of how this argument interacts with the admin argument.

NOTE: Autonegotiation is always disabled for 10Gb ports.

Argument	Description
	<p>NOTE: For 1Gb speeds over copper, autonegotiation must be enabled, per the IEEE 802.3 specification. Gb optical ports cannot enable autoneg.</p>
discovery <cdp lldp all disable>	<p>Configures port discovery options, as follows:</p> <ul style="list-style-type: none"> ▪ cdp—Enables CDP port discovery. ▪ lldp—Enables LLDP port discovery. ▪ all—Enables all port discovery protocols (meaning both CDP and LLDP). ▪ disable—Disables port discovery. <p>Discovery is disabled by default. To enable discovery, configure one or more protocols.</p>
duplex <full>	<p>Specifies the port's duplex configuration. Only full duplex is supported. Starting in software version 5.2, half duplex support is removed from all GigaVUE H Series nodes. If half duplex was configured in a previous software version, it will remain intact following the upgrade to 5.2 or higher release. Update to full duplex, if required.</p>
forcelinkup <disable enable>	<p>Forces connection on an optical port. Use this option when an optical tool port is connected to a legacy optical tool that does not transmit light.</p> <p>Available as follows:</p> <ul style="list-style-type: none"> ▪ Optical 1Gb/10Gb tool ports ▪ Not available for 10Gb-capable ports with a 1Gb SFP installed. 10Gb-capable optical tool ports only support forcelinkup when a 10Gb SFP+ is installed.
speed <10 100 1000 10000>	<p>Sets the port speed in Mbps if autonegotiation is off.</p>

Autonegotiation and External Fiber TAPs

When connecting a fiber port on the GigaVUE-HC2 node to an external TAP, autonegotiation is disabled on the node's fiber port, and cannot change.

Forcelinkup and Enabling/Disabling Ports

The GigaVUE-HC2 node includes both **forcelinkup** and **admin** arguments for the **port params** command. The **forcelinkup** argument forces the link state on an optical tool port connected to a legacy tool that does not transmit the light required to bring the link up. The following table summarizes how traffic flows for different combinations of **port params admin** and **port params forcelinkup** applied to an optical tool port.

	forcelinkup = disable	forcelinkup = enable
admin = enable	No traffic passed if autonegotiation is not successful.	Traffic is passed.
admin = disable	No traffic passed.	No traffic passed.

GigaVUE-HC2 Specifications

This appendix provides the physical specifications, power requirements, and environmental specifications for GigaVUE-HC2 nodes. Compliance for safety, emissions, and immunity are also provided.

Refer to the following sections for details:

- [Physical Dimensions and Weight](#)
- [Power Requirements](#)
- [Environmental Specifications](#)
- [Standards and Protocols](#)
- [Compliance](#)
- [Warranty](#)

Physical Dimensions and Weight

The following table summarizes the dimensions and weight for the GigaVUE-HC2 nodes and its modules:

Node	Height	Width	Depth	Weight
GigaVUE-HC2 (w/ 2 power supply + fan + Control Card)	2RU3.5in (8.9cm)	19.0in(48.3cm)	24.2in (61.6cm) without cable management 27.0in (68.6cm) with cable management	36.80lb (16.70kg)
PRT-HC0-X2424 x 10Gb Module	1.6in(4.1cm)	8.0in(20.3cm)	9.4in(23.8cm)	2.12lb(0.96kg)
PRT-HC0-Q066 x 40Gb Module	1.6in(4.1cm)	8.0in(20.3cm)	9.4in(23.8cm)	2.40lb(1.09kg)
PRT-HC0-C022 x 100Gb Module	1.6in(4.1cm)	8.0in(20.3cm)	9.4in(23.8cm)	2.30lb(1.04kg)
TAP-HC0-D25AC0SX/SR 50/12512 TAP Module	1.6in(4.1cm)	8.0in(20.3cm)	9.4in(23.8cm)	3.50lb(1.59kg)
TAP-HC0-D25BC0SX/SR 62.5/12512 TAP Module	1.6in(4.1cm)	8.0in(20.3cm)	9.4in(23.8cm)	3.50lb(1.59kg)
TAP-HC0-D35CC0LX/LR 12 TAP Module	1.6in(4.1cm)	8.0in(20.3cm)	9.4in(23.8cm)	3.50lb(1.59kg)
TAP-HC0-G100C0Copper (RJ-45)12 TAP Module	1.6in(4.1cm)	8.0in(20.3cm)	9.4in(23.8cm)	3.20lb(1.45kg)
SMT-HC0-RGigaSMART Rear Module	1.6in(4.1cm)	9.3in23.5cm	13.2in(33.6cm)	4.40lb(2.00kg)
SMT-HC0-X16GigaSMART	1.6in(4.1cm)	8.0in(20.3cm)	10.2in(26.0cm)	4.40lb(2.00kg)

Node	Height	Width	Depth	Weight
Front Module				
BPS-HC0-D25A4GBPS-HC0-D25B4GBPS-HC0-D35C4GBypass Combo Modules	1.6in(4.1cm)	8.0in(20.3cm)	10.5in(26.7cm)	3.60lb(1.63kg)
BPS-HC0-Q25A28Bypass Combo Module	1.6in(4.1cm)	8.0in(20.3cm)	10.5in(26.7cm)	3.14lb(1.42kg)

Battery Caution

A disposable, non-rechargeable, Real Time Clock (RTC) Lithium metal coin cell battery is in the GigaVUE-HC2. Note the following:

- There is a risk of fire if the battery is replaced with an incorrect type.
- Use only CR-2032L type Lithium metal coin cell battery and replace with the same.

Power Requirements

The following table summarizes the electrical characteristics of GigaVUE-HC2 nodes.

NOTE: Refer to [Figure 4DC Power Module](#) for instructions on how to connect DC power supplies.

Power Specification	Specification
Power Configurations	1+1 Power: 2 Power Supply Modules
Max Power Consumption/Heat Output	<ul style="list-style-type: none"> ▪ 960 Watts; 3276 BTU/hr (Control Card version 1) ▪ 960 Watts; 3276 BTU/hr (Control Card version 2) ▪ Fully populated system with all ports at 100% traffic load
AC Power Supply Modules	<ul style="list-style-type: none"> ▪ Min/Max Voltage: 100V–240V AC, 47-63Hz ▪ Max PSM Input Current: 14A@100V
DC Power Supplies	<ul style="list-style-type: none"> ▪ Min/Max Voltage: -36V to -72V DC ▪ Max PSM Input Current: 35A@ -36V

Environmental Specifications

The following table summarizes the environmental specifications for GigaVUE-HC2 nodes.

Specification	GigaVUE-HC2 Node
Operating Temperature	32°F to 104°F (0°C to 40°C)
Operating Relative Humidity	20% to 80%, non-condensing
Recommended Storage Temperature	-4°F to 158°F (-20°C to 70°C)
Recommended Storage Relative Humidity	15% to 85%, non-condensing
Altitude	Up to 15,000ft (4.6km)

Standards and Protocols

IEEE 802.3-2012, IEEE 802.1Q VLAN, IEEE 802.3 10BASE-T, IEEE 802.3u 100BASE-TX, IEEE 802.3ab 1000BASE-T, IEEE 802.3z 1000BASE-X, IEEE 802.3ae 10000BASE-X, IEEE 802.3ba, RFC 783 TFTP, RFC 791 IP, RFC 793, TCP, RFC 826 ARP, RFC 768 UDP, RFC 792 ICMP, SNMP v1/v2c, RFC 2131 DHCP client, RFC 1492 TACACS+, and support for IPv4 and IPv6.

Compliance

This section provides compliance information for GigaVUE-HC2.

Emissions

GigaVUE-HC2 is compliant with the following emissions regulations:

- FCC Part 15, Class A
- VCCI Class A. Refer to [Class A Information Technology Equipment \(ITE\)](#).
- EN55022/CISPR-22 Class A
- Australia/New Zealand AS/NZS CISPR-22 Class A
- CE Mark EN 55022 Class A
- Taiwan BSMI

Class A Information Technology Equipment (ITE)

Translation of Statement for Class A VCCI-certified Equipment:

This is a Class A product based on the standard of the Voluntary Control Council for Interference by Information Technology Equipment (VCCI). If this equipment is used in a domestic environment, radio disturbance may occur, in which case, the user may be required to take corrective action.

Environmental

GigaVUE-HC2 is compliant with the following environmental regulations:

- EU RoHS 6, EU directive 2011/65/EU
- NEBS Level 3. Refer to [Installation Instructions GigaVUE-HC2](#).

Immunity

GigaVUE-HC2 is compliant with the following immunity regulations:

- ETSI EN300 386 V1.3.2
- EN61000-4-2
- EN61000-4-3
- EN61000-4-4
- EN61000-4-5
- EN61000-4-6
- EN61000-3-2

Safety

GigaVUE-HC2 is compliant with the following safety regulations:

- UL 60950-1, 2nd Edition
- CAN/CSA C22.2 No. 60950-1-07, 2nd Edition
- EN 60950-1:2006/A11:2009/A1:2010/A12:2011/A2:2013
- IEC 60950-1:2005 (2nd Edition) + Am 1:2009 + Am 2:2013
- Taiwan BSMI. Refer to [Figure 1AC and DC Taiwan RoHS Tables for BSMI Compliance](#).

AC Version RoHS Table

設備名稱：企業網路綜合接入單元 Equipment name						
型號（型式）： GigaVUE-HC2, GVS-HC201, G GVS-HC2A1 Type designation (Type)						
單元Unit	限用物質及其化學符號 Restricted substances and its chemical symbols					
	鉛Lead (Pb)	汞Mercury (Hg)	鎘Cadmium (Cd)	六價鉻 Hexavalent chromium (Cr ⁶⁺)	多溴聯苯 Polybrominated biphenyls (PBB)	多溴二苯醚 Polybrominated diphenyl ethers (PBDE)
機殼 Chassis	○	○	○	○	○	○
電路板 PCB Board	○	○	○	○	○	○
電源供應器 Power Supply	—	○	○	○	○	○
內部配線 Internal wiring	○	○	○	○	○	○
備考1. “超出0.1 wt %” 及 “超出0.01 wt %” 係指限用物質之百分比含量超出百分比含量基準值。 Note 1: “Exceeding 0.1 wt %” and “exceeding 0.01 wt %” indicate that the percentage content of the restricted substance exceeds the reference percentage value of presence condition.						
備考2. “○” 係指該項限用物質之百分比含量未超出百分比含量基準值。 Note 2: “○” indicates that the percentage content of the restricted substance does not exceed the percentage of reference value of presence.						
備考3. “—” 係指該項限用物質為排除項目。 Note 3: The “—” indicates that the restricted substance corresponds to the exemption.						

DC Version RoHS Table

設備名稱：企業網路綜合接入單元 Equipment name						
型號（型式）： GigaVUE-HC2, GVS-HC202, GVS-HC2A2 Type designation (Type)						
單元Unit	限用物質及其化學符號 Restricted substances and its chemical symbols					
	鉛Lead (Pb)	汞Mercury (Hg)	鎘Cadmium (Cd)	六價鉻 Hexavalent chromium (Cr ⁶⁺)	多溴聯苯 Polybrominated biphenyls (PBB)	多溴二苯醚 Polybrominated diphenyl ethers (PBDE)
機殼 Chassis	○	○	○	○	○	○
電路板 PCB Board	○	○	○	○	○	○
電源供應器 Power Supply	○	○	○	○	○	○ 90
內部配線 Internal wiring	○	○	○	○	○	○

Figure 1 AC and DC Taiwan RoHS Tables for BSMI Compliance

Security

GigaVUE-HC2 is compliant with the following security certifications:

- FIPS 140-2. Refer to “FIPS 140-2 Compliance” in the *GigaVUE-OS CLI User's Guide*.
- UC APL (option available). Refer to “UC APL Compliance” in the *GigaVUE-OS CLI User's Guide*.
- Common Criteria (option available). Refer to “Common Criteria” in the *GigaVUE-OS CLI User's Guide*.

GigaVUE-HC2 is compliant with the following safety regulations:

- UL 60950-1, 2nd Edition
- CAN/CSA C22.2 No. 60950-1-07, 2nd Edition
- EN 60950-1:2006/A11:2009/A1:2010/A12:2011/A2:2013
- IEC 60950-1:2005 (2nd Edition) + Am 1:2009 + Am 2:2013
- Taiwan BSMI. Refer to [Figure 2AC and DC Taiwan RoHS Tables for BSMI Compliance](#).

AC Version RoHS Table

設備名稱：企業網路綜合接入單元 Equipment name 型號（型式）： GigaVUE-HC2, GVS-HC201, G GVS-HC2A1 Type designation (Type)						
單元Unit	限用物質及其化學符號 Restricted substances and its chemical symbols					
	鉛Lead (Pb)	汞Mercury (Hg)	鎘Cadmium (Cd)	六價鉻 Hexavalent chromium (Cr ⁶⁺)	多溴聯苯 Polybrominated biphenyls (PBB)	多溴二苯醚 Polybrominated diphenyl ethers (PBDE)
機殼 Chassis	○	○	○	○	○	○
電路板 PCB Board	○	○	○	○	○	○
電源供應器 Power Supply	—	○	○	○	○	○
內部配線 Internal wiring	○	○	○	○	○	○
備考1. “超出0.1 wt %” 及 “超出0.01 wt %” 係指限用物質之百分比含量超出百分比含量基準值。 Note 1: “Exceeding 0.1 wt %” and “exceeding 0.01 wt %” indicate that the percentage content of the restricted substance exceeds the reference percentage value of presence condition.						
備考2. “○” 係指該項限用物質之百分比含量未超出百分比含量基準值。 Note 2: “○” indicates that the percentage content of the restricted substance does not exceed the percentage of reference value of presence.						
備考3. “—” 係指該項限用物質為排除項目。 Note 3: The “—” indicates that the restricted substance corresponds to the exemption.						

DC Version RoHS Table

設備名稱：企業網路綜合接入單元 Equipment name 型號（型式）： GigaVUE-HC2, GVS-HC202, GVS-HC2A2 Type designation (Type)						
單元Unit	限用物質及其化學符號 Restricted substances and its chemical symbols					
	鉛Lead (Pb)	汞Mercury (Hg)	鎘Cadmium (Cd)	六價鉻 Hexavalent chromium (Cr ⁶⁺)	多溴聯苯 Polybrominated biphenyls (PBB)	多溴二苯醚 Polybrominated diphenyl ethers (PBDE)
機殼 Chassis	○	○	○	○	○	○
電路板 PCB Board	○	○	○	○	○	○
電源供應器 Power Supply	○	○	○	○	○	○ 92
內部配線 Internal wiring	○	○	○	○	○	○

Figure 2 AC and DC Taiwan RoHS Tables for BSMI Compliance

Emissions

GigaVUE-HC2 is compliant with the following emissions regulations:

- FCC Part 15, Class A
- VCCI Class A. Refer to [Class A Information Technology Equipment \(ITE\)](#).
- EN55022/CISPR-22 Class A
- Australia/New Zealand AS/NZS CISPR-22 Class A
- CE Mark EN 55022 Class A
- Taiwan BSMI

Class A Information Technology Equipment (ITE)

Translation of Statement for Class A VCCI-certified Equipment:

This is a Class A product based on the standard of the Voluntary Control Council for Interference by Information Technology Equipment (VCCI). If this equipment is used in a domestic environment, radio disturbance may occur, in which case, the user may be required to take corrective action.

GigaVUE-HC2 is compliant with the following immunity regulations:

- ETSI EN300 386 V1.3.2
- EN61000-4-2
- EN61000-4-3
- EN61000-4-4
- EN61000-4-5
- EN61000-4-6
- EN61000-3-2

GigaVUE-HC2 is compliant with the following environmental regulations:

- EU RoHS 6, EU directive 2011/65/EU
- NEBS Level 3. Refer to [Installation Instructions GigaVUE-HC2](#).

GigaVUE-HC2 is compliant with the following security certifications:

- FIPS 140-2. Refer to “FIPS 140-2 Compliance” in the *GigaVUE-OS CLI User's Guide*.
- UC APL (option available). Refer to “UC APL Compliance” in the *GigaVUE-OS CLI User's Guide*.
- Common Criteria (option available). Refer to “Common Criteria” in the *GigaVUE-OS CLI User's Guide*.

Warranty

Gigamon offers a range of premium support and extended services. For details regarding warranty, visit: <https://www.gigamon.com/support-and-services/warranty>

Replacing a Control Card

This appendix describes how to replace a control card in a GigaVUE-HC2. Since there is only one control card, and it is internal, the unit must be powered down for any first time installation or remove and replacement.

Use this appendix for replacing an existing control card with the same control card.

Use the following appendix for replacing an existing control card with the GigaVUE-HC2 Control Card version 2 (HC2 v2): [Upgrading to HC2 CCv2](#).



Figure 1 *Replacing a Control Card*

1. Log in to the serial console port on the node with the control card to be replaced and power it down gracefully with **reload halt** command, confirming your decision when prompted, as follows:

```
Node_A [100: standby] (config) # reload halt
Confirm reboot/halt? [no] yes
Halting system...
Node_A [100: standby] (config) #
System shutdown initiated -- logging off.
Gigamon GigaVUE H Series H Series Chassis
INIT:Stopping pm: [ OK ]
Shutting down kernel logger: [ OK ]
Shutting down system logger: [ OK ]
Starting killall: Shutting down TFTP server: [ OK ]
[ OK ]
Sending all processes the TERM signal...
Sending all processes the KILL signal...
Remounting root filesystem in read-write mode:
Saving random seed:
Syncing hardware clock to system time
Running vpart script:
Unmounting file systems:
Remounting root filesystem in read-only mode:
Running vpart script:
Halting system...
sd 0:0:0:0: [sda] Stopping disk
Power down.
```

2. If the GigaVUE-HC2 is a member node, from the SSH session to the VIP/Leader IP address, check the cluster's operating parameters with the **show chassis** and **show cluster global** commands, as follows. Record the values shown for the **Cluster ID**, **Cluster Name**, and **Cluster Management IP** – for use when reconfiguring the node with its new control card.

```
Node_B [100: leader] (config) # show chassis
```

```
Box# Hostname Config Oper Status HW Type Product# Serial# HW Rev SW Rev
```

```
-----
```

```
2 * Node_B yes up HC2-Chassis 132-0098 80103 A3 2.7.0
```

```
1 - yes down HC2-Chassis 132-0098 80018 - -
```

```
Node_B [100: leader] (config) # show cluster global
```

```
Cluster ID: 100
```

```
Cluster name: 100
```

```
Management IP: 10.150.52.232/24
```

```
Cluster leader IF: eth0
```

```
Cluster node count: 1
```

```
Node Status:
```

```
Node ID: 2 <--- (local node)
```

```
Host ID: ecde217e8354
```

```
Hostname: Node_B
```

```
Box-id: 2
```

```
Uptime: 0d 00h 23m 00s
```

```
CC1/CC2 Dynamic Sync status: in sync
```

```
Node Role:leader
```

```
Node State: online
```

```
Node internal address: 169.254.126.51, port: 60102
```

```
Node external address: 10.150.52.10
```

```
Recv. Heartbeats from: -1
```

```
Send Heartbeats to: -1
```

```
Node_B [100: leader] (config) #
```

3. In a stand-alone GigaVUE-HC2 use **show running-config** command, backup the entire system configuration to a text file, which can be used to reconfigure the new control card.
4. Power down the unit.
5. Remove the electrical connections from the unit.
6. Using a Phillips screw driver, remove the screws holding the fan unit at the back of the GigaVUE-HC2.
7. Remove the fan unit from the back of the unit.
8. Be sure to use an ESD grounding strap on your wrist or ankle before touching any cards.
9. Slide the control card out from the back side of the unit.
10. Slide the new control card into the GigaVUE-HC2.

11. Power-up the node.
12. Log on to the node over the console port.
13. Switch to **Configure** mode.
 - a. Type **en <Enter>** to switch to Enable mode.
 - b. Type **config t <Enter>** to switch to Configure mode.
14. Run the jump-start script with the following command if it does not appear automatically:
(config) # config jump-start
15. Follow the jump-start script's prompts to reconfigure the node with the settings for the existing cluster you recorded in [Step](#) , as follows.

Gigamon GigaVUE H Series H Series Chassis

gigamon-0d04f1 login: admin

Gigamon GigaVUE H Series H Series Chassis

GigaVUE-OS configuration wizard

Do you want to use the wizard for initial configuration? yes

Step 1: Hostname? [gigamon-0d04f1] Node_A

Step 2: Management interface? [eth0]

Step 3: Use DHCP on eth0 interface? no

Step 4: Use zeroconf on eth0 interface? [no]

Step 5: Primary IPv4 address and masklen? [0.0.0.0/0] 10.150.52.2/24

Step 6: Default gateway? 10.150.52.1

Step 7: Primary DNS server? 192.168.2.20

Step 8: Domain name? gigamon.com

Step 9: Enable IPv6? [yes]

Step 10: Enable IPv6 autoconfig (SLAAC) on eth0 interface? [no]

Step 11: Enable DHCPv6 on eth0 interface? [no]

Step 12: Enable secure cryptography? [no]

Step 13: Enable secure passwords? [no]

Step 14: Minimum password length? [8]

Step 15: Admin password?

Please enter a password. Password is a must.

Step 15: Admin password?

Step 15: Confirm admin password?

Step 16: Cluster enable? [no] yes

Step 17: Cluster interface? [eth2]

Step 18: Cluster id (Back-end may take time to proceed)? [default-cluster] 100

Step 19: Cluster name? [default-cluster] 100

Step 20: Cluster Leader Preference (strongly recommend the default value)? [60]

Step 21: Cluster mgmt IP address and masklen? [0.0.0.0/0] 10.150.52.232/24

You have entered the following information:

- 1. Hostname: Node_A**
- 2. Management interface: eth0**
- 3. Use DHCP on eth0 interface: no**
- 4. Use zeroconf on eth0 interface: no**
- 5. Primary IPv4 address and masklen: 10.150.52.2/24**
- 6. Default gateway: 10.150.52.1**
- 7. Primary DNS server: 192.168.2.20**
- 8. Domain name: gigamon.com**

...

To change an answer, enter the step number to return to.
Otherwise hit <enter> to save changes and exit.

Choice:

Configuration changes saved.

To return to the wizard from the CLI, enter "configuration jump-start"
command from configure mode. Launching CLI...

*** Warning: This system is a member of a cluster. Shared configuration
must be changed on the cluster leader.

Cluster ID: 100

Cluster name: 100

Management IP: 10.150.52.232/24

Cluster leader IF: eth0

Cluster node count: 2

Local name: Node_A

Local role: standby

Local state: online

Leader address: 10.150.52.10 (ext) 169.254.126.51 (int)

Leader state: online

The serial number from the Node_A chassis is still in the cluster's global configuration database. When the cluster detects **Node_A** trying to join the cluster with a serial number it recognizes, it automatically configures the node with the box ID and packet distribution configuration associated with that serial number before the control card was replaced.

16. Next, run a series of **show** commands to verify that the node and cluster are operating as expected:
 - a. From the VIP/Leader IP address, run **show version box-id <id>** to make sure the correct images are loaded on the node. For example:

```

Node_B [100: leader] (config) # show version box-id 1

=== Box-id : 1 (Role: standby) === Hostname: Node_A ===
Installed images:
Partition 1: (cur, next)
GigaVUE H Series-H Series 2.7.0 #103-dev 2013-02-15 05:09:08 ppc gvc2 build_
master@BuildMaster:svn17810
Partition 2:
GigaVUE H Series-H Series 2.7.0 #103-dev 2013-02-15 05:09:08 ppc gvc2 build_
master@BuildMaster:svn17810

U-Boot version: 2011.06.10

```

- b. From the VIP/Leader IP address, run the **show cluster global** and **show chassis** commands to assure yourself that the cluster is stable and reliable. For example:

```

Node_B [100: leader] (config) # show cluster global
Cluster ID: 100
Cluster name: 100
Management IP: 10.150.52.232/24
Cluster leader IF: eth0
Cluster node count: 2

Node Status:
Node ID: 4
Host ID: 6c9834bec584
Hostname: Node_A
Box-id: 1
Uptime: 0d 00h 02m 55s
CC1/CC2 Dynamic Sync status: in sync
Node Role: standby
Node State: online
Node internal address: 169.254.46.92, port: 51612
Node external address: 10.150.52.2
Recv. Heartbeats from: 2
Send Heartbeats to: 2
Node_B [100: leader] (config) # show chassis
Box# Hostname Config Oper Status HW Type Product# Serial # HW Rev SW Rev
-----
1 Node_A yes up      HC2-Chassis 132-0098 80018  2.0 2.7.0
[100: leader] (config) #

```



```
Node_B [100: leader] (config) # clear port stats port 2/1/x6,1/3/x1
```

```
Counter Name Port: 1/3/x1
```

```
=====
```

```
IfInOctets:
```

```
IfInUcastPkts: 0
```

```
IfInNUcastPkts: 0
```

```
IfInPktDrops: 0
```

```
IfInDiscards: 0
```

```
IfInErrors: 0
```

```
IfInOctetsPerSec: 0
```

```
IfInPacketsPerSec: 0
```

```
Node_B [100: leader] (config) # show port stats port 2/1/x6,1/3/x1
```

```
Counter Name Port: 2/1/x6 Port: 1/3/x1
```

```
=====
```

```
IfInOctets: 2017430592
```

```
IfInUcastPkts: 31522353
```

```
IfInNUcastPkts: 0
```

```
IfInPktDrops: 0
```

```
IfInDiscards: 0
```

```
IfInErrors: 0
```

```
IfInOctetsPerSec: 0
```

```
IfInPacketsPerSec: 0
```

Upgrading to HC2 CCv2

This appendix describes how to upgrade an existing GigaVUE-HC2 control card to GigaVUE-HC2 Control Card version 2 (HC2 CCv2). Refer to the following sections for details:

- [Standalone Node](#)
- [Node in Out-of-Band Cluster](#)
- [Node in Inband Cluster](#)

PREREQUISITE: Install software version 4.6 or higher before upgrading the control card to HC2 CCv2.

NOTE: Be sure to use an ESD grouping strap on your wrist or ankle before touching any cards.

Standalone Node

NOTE: The following procedure is for a standalone GigaVUE-HC2 node to upgrade the control card to HC2 CCv2. The software version on the HC2 CCv2 will be 4.6 or higher.

Before starting the procedure, backup the entire configuration on the node to a text file. This will later be used to reconfigure the HC2 CCv2.

```
(config) # configuration text generate active running upload <ftp | tftp | scp |  
sftp>://<upload URL>/<filename.txt>
```

To upgrade a standalone GigaVUE-HC2 node to HC2 CCv2:

1. Log in to the serial console port on the node with the control card to be replaced and power it down gracefully with the **reload halt** command, confirming your decision when prompted, as follows:

```
Node_A [100: standby] (config) # reload halt
Confirm reboot/halt? [no] yes
Halting system...
Node_A [100: standby] (config) #
System shutdown initiated -- logging off.
Gigamon GigaVUE H Series H Series Chassis
INIT:Stopping pm: [ OK ]
Shutting down kernel logger: [ OK ]
Shutting down system logger: [ OK ]
Starting killall: Shutting down TFTP server: [ OK ]
[ OK ]
Sending all processes the TERM signal...
Sending all processes the KILL signal...
Remounting root filesystem in read-write mode:
Saving random seed:
Syncing hardware clock to system time
Running vpart script:
Unmounting file systems:
Remounting root filesystem in read-only mode:
Running vpart script:
Halting system...
sd 0:0:0:0: [sda] Stopping disk
Power down.
```

2. Power down the standalone node by unplugging the power cable.
3. The control card is located below the fan tray unit, which must be removed to access the control card. Remove the two screws on the fan tray unit as shown in the following figure, then remove the fan tray unit.

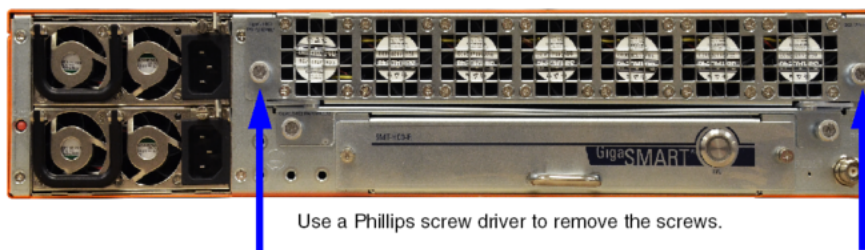

4. Remove two lower screws as shown in the following figure.

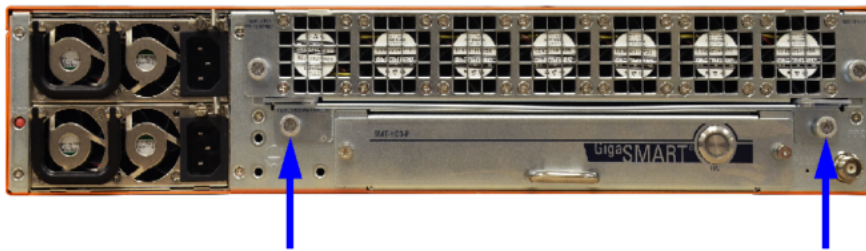

5. Turn both latches outward as shown in the following figure to release the control card from the chassis.

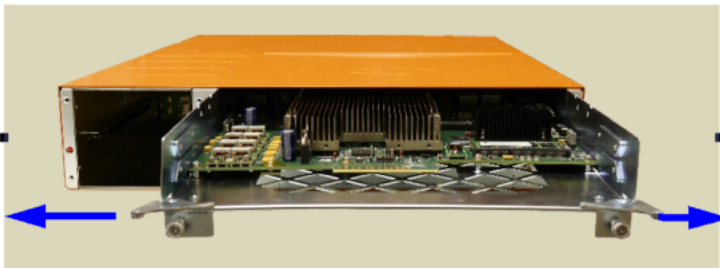

6. Remove the existing control card.
7. Insert the new HC2 CCv2 control card.
8. Turn both latches inward.
9. Replace the two lower screws.
10. Insert the fan tray unit and replace the two screws on the fan tray unit.
11. Plug in the power cable.
12. When the node powers up, log on to it over the console port.
13. Switch to **Configure** mode.
 - a. Type **en <Enter>** to switch to Enable mode.
 - b. Type **config t <Enter>** to switch to Configure mode.
14. Run the jump-start script with the following command if it does not appear automatically:

```
(config) # config jump-start
```

15. Follow the prompts for the jump-start script.
16. When the jump-start script has completed, run the following command to make sure the node has an IP address:

```
(config) # show interface eth0
```

17. Log into the node and run the **show card** command. Refer to the following sample output. Verify that the control card in the cc1 slot has the correct type: HC2-Main-Board-v2. Initially, the other cards will be down and only the control card will be operationally up.

```
(config) # show card
Box ID: 1
Slot  Config  Oper Status      HW Type          Product Code  Serial Num  HW Rev
-----
cc1   yes      up              HC2-Main-Board-v2  132-00C2      1C20-0057   1.0-a0
1     yes      down           PRT-HC0-Q06      132-00BE      1BE0-01A2   B1-a3
2     yes      down           PRT-HC0-C02      132-00CR      1CR0-0034   3.0-a5
3     yes      down           SMT-HC0-X16      132-00BK      1BK0-001D   1.5-2
```

18. Apply the previously saved configuration, using the following command:

```
(config) # configuration text fetch <http | https | ftp | tftp | scp | sftp>://<download
URL>/<filename.txt> apply fail-continue verbose
```

19. Verify that the information on the GigaVUE-HC2 with Control Card version 2 matches the previously saved configuration for chassis, cards, and traffic using the following CLI commands or others, depending on your configuration:

```
(config) # show version
(config) # show chassis
(config) # show cards
(config) # show map
(config) # show map stats all
```

Node in Out-of-Band Cluster

The following procedure is for a GigaVUE-HC2 node in an out-of-band cluster to upgrade the control card to HC2 CCv2.

NOTE: The HC2 CCv2 requires software version 4.6 or higher.

Before starting this procedure, upgrade all the nodes in the cluster to 4.6 or higher. Then use the **show chassis** command to record the GigaVUE-HC2 chassis box ID and the **show cluster config** command to record the cluster ID, cluster name, cluster leader address vip, cluster leader preference, and cluster interface.

To upgrade a GigaVUE-HC2 that is in an out-of-band cluster to HC2 CCv2:

1. On the cluster leader node, backup the entire configuration on the cluster to a text file.

```
(config) # configuration text generate active running upload <ftp | tftp | scp |
sftp>://<upload URL>/<filename.txt>
```

2. On the cluster leader node, remove the configuration with the GigaVUE-HC2 node from the cluster database. The commands may vary depending on your configuration.

```
(config) # no map all
(config) # no gsop all
(config) # no vport all
(config) # no tunnel all
(config) # no gsgroup all
(config) # no stack alias <alias>
```

3. On the GigaVUE-HC2 node, issue the following commands:

(config) # no cluster enable(config) # write memory

4. On the cluster leader, remove the GigaVUE-HC2 node information from the cluster database. Answer YES when prompted. This removes the GigaVUE-HC2 from the cluster.

```
(config) # no chassis box-id <box ID>
```

WARNING !! All the cards, ports, and traffic configuration will be lost.

Enter 'YES' to confirm this operation: YES

5. Upgrade the GigaVUE-HC2 to HC2 CCv2 by following the procedure for [Standalone Node](#) up to and including [Step](#) . (Since the GigaVUE-HC2 has been removed from the cluster, it is a standalone node.)
6. When the GigaVUE-HC2 with HC2 CCv2 is back up, reinstate the cluster configuration including the cluster ID, cluster name, cluster leader address vip, cluster leader preference, and cluster interface, as well as the chassis box ID.

```
(config) # cluster id <cluster ID>(config) # cluster name <cluster name>(config) #
cluster leader address vip <cluster leader vip>(config) # cluster interface eth<x>(config)
# cluster leader preference <preference number for leader, standby, or normal>
```

7. On the cluster leader, configure chassis information on the GigaVUE-HC2 with HC2 CCv2, including the chassis box ID, serial number, and new node type.

```
(config) # chassis box-id <box ID> serial-num <serial number> type hc2-v2
```

8. On the GigaVUE-HC2 with HC2 CCv2 node, issue the following command for the node to rejoin the cluster:

```
(config) # cluster enable
```

9. When the GigaVUE-HC2 with HC2 CCv2 node is in the cluster, from the cluster leader apply the previously saved configuration:

```
(config) # configuration text fetch <http | https | ftp | tftp | scp | sftp>://<download
URL>/<filename.txt> apply fail-continue verbose
```

10. Verify that the information on the cluster matches the previously saved configuration for chassis, cards, and traffic using the following CLI commands or others, depending on your configuration:

```
(config) # show version(config) # show cluster global(config) # show chassis(config) #
show cards(config) # show map(config) # show map stats all
```

Node in Inband Cluster

The following procedure is for a GigaVUE-HC2 node in an inband cluster to upgrade the control card to HC2 CCv2.

NOTE: The HC2 CCv2 requires software version 4.6 or higher.

Before starting this procedure, upgrade all the nodes in the cluster to 4.6 or higher. Then use the **show chassis** command to record the GigaVUE-HC2 chassis box ID and the **show cluster config** command to record the cluster ID, cluster name, cluster leader address vip, cluster leader preference, and cluster interface.

To upgrade a GigaVUE-HC2 that is in an inband cluster to HC2 CCv2:

1. On the cluster leader, backup the entire configuration on the cluster to a text file.

```
(config) # configuration text generate active running upload <ftp | tftp | scp |
sftp>://<upload URL>/<filename.txt>
```

2. On the cluster leader, remove the configuration with the GigaVUE-HC2 node from the cluster database. The commands may vary depending on your configuration.

```
(config) # no map all(config) # no gsop all(config) # no vport all(config) # no tunnel all
(config) # no gsgroup all(config) # no stack alias <alias>
```

3. On the GigaVUE-HC2 node, issue the following commands:

```
(config) # no cluster enable(config) # write memory
```

4. On the cluster leader, remove the GigaVUE-HC2 node information from the cluster database. Answer YES when prompted. This removes the GigaVUE-HC2 from the cluster.

```
(config) # no chassis box-id <box ID>
```

WARNING !! All the cards, ports, and traffic configuration will be lost.

Enter 'YES' to confirm this operation: YES

5. Upgrade the GigaVUE-HC2 to HC2 CCv2 by following the procedure for [Standalone Node](#) up to and including [Step](#) . (Since the GigaVUE-HC2 has been removed from the cluster, it is a standalone node.)
6. When the GigaVUE-HC2 with HC2 CCv2 is back up, reinstate the original cluster configuration including the cluster ID, cluster name, cluster leader address vip, cluster leader preference, and cluster interface, as well as the chassis box ID. Then reinstate the interface configuration, chassis and card configuration, and GigaStream configuration used for the inband cluster stack-links.

The cluster configuration is as follows:

```
(config) # cluster id <cluster ID>(config) # cluster name <cluster name>(config) #
cluster leader address vip <cluster leader vip>(config) # cluster interface <interface>
(config) # cluster leader preference <preference number for leader, standby, or
normal>
```

The interface configuration is as follows:

```
(config) # no interface eth1 zeroconf(config) # no interface eth2 zeroconf(config) #
interface inband zeroconf
```

The chassis and card configuration is as follows:

```
(config) # chassis box-id <box ID>(config) # card slot <slot number>
```

The GigaStream configuration is as follows:

```
(config) # port <box ID>/<slot number>/<stack ports> params admin enable
(config) # port <box ID>/<slot number>/<stack ports> type stack
(config) # gigastream alias <GigaStream alias>
port-list <box ID>/<slot number>/<stack ports>
```

- On the cluster leader, configure the GigaVUE-HC2 with HC2 CCv2 offline. The offline provisioning includes chassis, card, port, and GigaStream stack port configuration. The chassis configuration includes the chassis box ID, serial number, and new GigaVUE-HC2 with HC2 CCv2 node type of hc2-v2.

```
(config) # chassis box-id <box ID> serial-num <serial number> type hc2-v2
(config) # card slot <box ID>/<slot number> product-code <card product code for HC2 CCv2>
(config) # port <box ID>/<slot number>/<stack ports> params admin enable
(config) # port <box ID>/<slot number>/<stack ports> type stack
(config) # gigastream alias <GigaStream alias>
port-list <box ID>/<slot number>/<stack ports>
```

NOTE: [Step](#) configures the GigaVUE-HC2 with HC2 CCv2. [Step](#) configures the cluster leader. The stack ports in [Step](#) are the same as those in [Step](#), under GigaStream configuration.

- On the GigaVUE-HC2 with HC2 CCv2 node, issue the following command for the node to rejoin the cluster:

```
(config) # cluster enable
```

- When the GigaVUE-HC2 with HC2 CCv2 node is in the cluster, from the cluster leader apply the previously saved configuration:

```
(config) # configuration text fetch <http | https | ftp | tftp | scp | sftp>://<download URL>/<filename.txt> apply fail-continue verbose
```

- Verify that the information on the cluster matches the previously saved configuration for chassis, cards, and traffic using the following CLI commands or others, depending on your configuration:

```
(config) # show version
(config) # show cluster global
(config) # show chassis
(config) # show cards
(config) # show map
(config) # show map stats all
```

Console Port Signaling and Cabling

This appendix provides the pin-outs for the RJ45-to-RJ45 rollover cable and RJ45-to-DB-9 adapter provided with the GigaVUE-HC2 node for connections from the node's console port to a PC's COM port.

The following figure shows how to connect the RJ45-to-RJ45 rollover cable from the GigaVUE-HC2 node's console port to a COM port on a PC using the RJ45-to-DB-9 adapter.

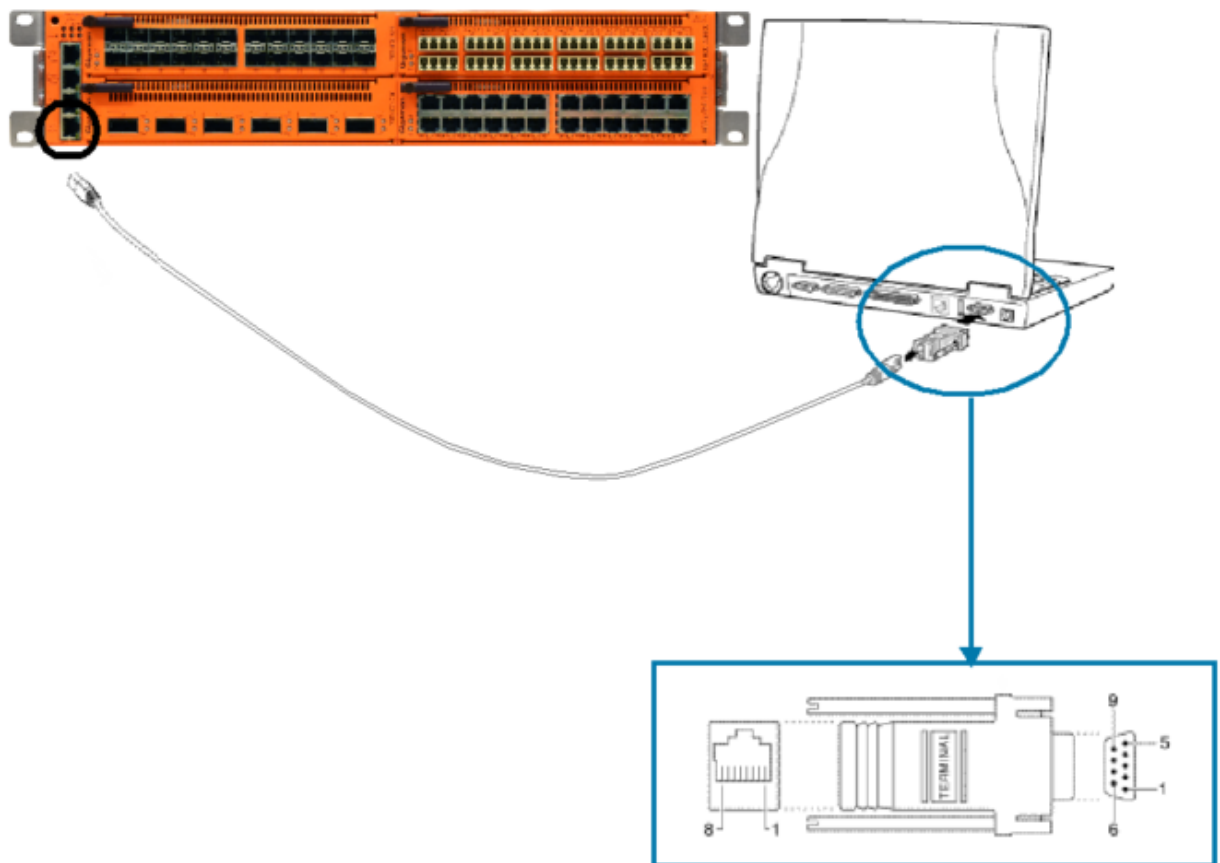

The following table lists the pinouts for this connection.

Console Port from GigaVUE-HC2 RJ45 Jack	RJ45-to-RJ45 Rollover Cable		RJ45-to-DB-9 Terminal Adapter	Console Device on PC
Signal	RJ45 Pin	RJ45 Pin	DB-9 Pin	Signal
N/A	1	8	8	N/A
N/A	2	7	6	N/A
TxD	3	6	2	RxD
GND	4	5	5	GND
GND	5	4	5	GND
RxD	6	3	3	TxD
N/A	7	2	4	N/A
N/A	8	1	7	N/A

NEBS Level 3 Compliance

This appendix provides installation instructions for GigaVUE-HC2 Network Equipment-Building System (NEBS) Level 3 compliance. Refer to the following section for details.

- [Installation Instructions GigaVUE-HC2](#)

Installation Instructions GigaVUE-HC2

The following sections detail installation instructions for GigaVUE-HC2.

Intrabuilding or Intra-connection

WARNING: The intra-building ports:

- BNC Coaxial PPS
- RJ45: PTP-1588, Management port, Console port
- PRT-HC0-X24
 - 1G/10G SFP/SFP+: X1 – X24
- PRT-HC0-Q06
 - 40G QSFP+: Q1 – Q6
- PRT-HC0-C02
 - 100G QSFP28: C1 - C2
- TAP-HC0-D25AC0
 - TAP SX/SR (50/125 μ m) 12 pairs: X1 – X24
- TAP-HC0-D25BC0
 - TAP SX/SR (62.5/125 μ m) 12 pairs: X1 – X24
- TAP-HC0-D35CC0
 - TAP LX/LR 12 pairs: X1 – X24
- TAP-HC0-G100C0
 - TAP 1G Copper 12 pairs: G1 – G24
- BPS-HC0-D25A4G
 - 1G/10G SFP/SFP+: X1 – X16
 - BPS SX/SR (50/125 μ m) 4 pairs: X17 – X24
- BPS-HC0-D25B4G
 - 1G/10G SFP/SFP+: X1 – X16
 - BPS SX/SR (62.5/125 μ m) 4 pairs: X17 – X24
- BPS-HC0-D35C4G
 - 1G/10G SFP/SFP+: X1 – X16
 - BPS LX/LR 4 pairs: X17 – X24
- SMT-HC0-X16

- o 1G/10G SFP/SFP+: X1 – X16

GigaVUE-HC2 equipment or subassembly are suitable for connection to intrabuilding or unexposed wiring or cabling only. The intra-building port(s) of the equipment or subassembly MUST NOT be metalically connected to interfaces that connect to the OSP or its wiring. These interfaces are designed for use as intra-building interfaces only (Type 2 or Type 4 ports as described in GR-1089-CORE, Issue 6) and require isolation from the exposed OSP cabling. The addition of Primary Protectors is not sufficient protection in order to connect these interfaces metalically to OSP wiring.

Intrabuilding Ports (RJ45)

WARNING: The intrabuilding ports (RJ45) shall be connected to shielded and grounded cables at both ends.

Class A2 Voltage Accessibility

The GigaVUE-HC2 shall be located in a restricted access location where only crafts personnel are allowed access.

Class B Voltage Accessibility

The GigaVUE-HC2 shall be located in a restricted access location where only crafts personnel are allowed access.

Equipment Grounding Systems

The GigaVUE-HC2 shall be installed and connected to the (CBN).

Communication Equipment Grounding

The GigaVUE-HC2 is suitable for connection to the (Central Office and CPE).

Bonding of Battery Return (BR) Input Terminals

The battery returns of the GigaVUE-HC2 shall be connected as (DC-I).

Connections

- a. The GigaVUE-HC2 shall be grounded via a copper ground conductor #6 AWG for CPE installation.
- b. All bare grounding connection points to the GigaVUE-HC2 shall be cleaned and coated with an antioxidant solution before connections are made.
- c. All surfaces on the GigaVUE-HC2 that are unplated shall be brought to a bright finish and treated with an antioxidant solution before connections are made.
- d. All non-conductive surfaces on the GigaVUE-HC2 shall be removed from all threads and connection points to ensure electrical continuity.
- e. Multiple connectors shall not be secured by the same bolt assemblies.

- f. Unplated connection surfaces that are to be intentionally joined to form a bonding or grounding path shall be brought to a bright finish and then coated with an antioxidant before they are joined (electrical connections).
- g. Listing fastening hardware shall be compatible with materials being joined and shall preclude loosening deterioration, and electrochemical corrosion of the hardware and joined materials.
- h. Non-conductive coatings (such as paint, lacquer, and enamel) on the equipment to be bonded or grounded shall be removed from threads and other contact surfaces to assure electrical continuity.
- i. GigaVUE-HC2 utilizes a Spade width 0.32in/.81cm with a Standard Wire 12-16 (AWG) that utilizes 5in-lbs of torque to secure it to the frame and EUT. Only listed two-hole compression-type connectors shall be used in making connection to flat surfaces (such as bus bars, frames, racks, or cabinets). Torquing and bolts assembly requirements for securing the connector shall be as specified by the connector supplier.
- j. Anti-rotation devices, such as lock washers, will be used on grounding lugs to minimize the possibility of loosening from rotation during installation and maintenance activities.

Input AC/DC Voltage

The GigaVUE-HC2 is capable of operating input 100-240V AC, 14-7A, 47-63Hz and/or -48V DC, 35-16A, 30A slow-blow.

Commercial Power Ports

The manufacturer recommends that Surge Protection Device (SPD) is intended to be used with AC-power equipment. The SPD, if used, is installed at the AC power entrance (Refer to definition in the NEC).

Maintenance

CAUTION: Remove all power sources before servicing. (TO COMPLETELY REMOVE POWER FROM THE UNIT, FIRST TURN OFF THE POWER SWITCH AND REMOVE BOTH POWER CABLES).

Additional Sources of Information

This appendix provides additional sources of information. Refer to the following sections for details:

- [Documentation](#)
- [Documentation Feedback](#)
- [Contact Technical Support](#)
- [Contact Sales](#)
- [The Gigamon Community](#)

Documentation

This table lists all the guides provided for GigaVUE H Series software and hardware. The first row provides an All-Documents Zip file that contains all the guides in the set for the release.

NOTE: In the online documentation, view [What's New](#) to access quick links to topics for each of the new features in this Release; view [Documentation Downloads](#) to download all PDFs.

Table 1: Documentation Set for Gigamon Products

GigaVUE H Series 6.0 Hardware and Software Guides
<p>DID YOU KNOW? If you keep all PDFs for a release in common folder, you can easily search across the doc set by opening one of the files in Acrobat and choosing Edit > Advanced Search from the menu. This opens an interface that allows you to select a directory and search across all PDFs in a folder.</p>
<p>Hardware</p> <p>how to unpack, assemble, rack-mount, connect, and initially configure ports the respective GigaVUE H Series devices; reference information and specifications for the respective GigaVUE H Series devices</p>
<p>*G-TAP A Series 2 Installation Guide</p>
<p>GigaVUE-HC1 Hardware Installation Guide</p>
<p>GigaVUE-HC2 Hardware Installation Guide</p>
<p>GigaVUE-HC3 Hardware Installation Guide</p>
<p>GigaVUE-HC1-PLUS Hardware Installation Guide</p>
<p>GigaVUE M Series Hardware Installation Guide</p>
<p>GigaVUE-TA25 Hardware Installation Guide</p>
<p>GigaVUE-TA200 Hardware Installation Guide</p>

GigaVUE H Series 6.0 Hardware and Software Guides

GigaVUE-TA400 Hardware Installation Guide

GigaVUE-TA10 Hardware Installation Guide

GigaVUE-TA40 Hardware Installation Guide

GigaVUE-TA100 Hardware Installation Guide

GigaVUE-TA100-CXP Hardware Installation Guide

***GigaVUE-OS Installation Guide for DELL S4112F-ON**

GigaVUE-FM Hardware Appliance Guide for GFM-HW1-FM010 and and GFM-HW1-FM001-HW

Software Installation and Upgrade Guides

GigaVUE-FM Installation, Migration, and Upgrade Guide

GigaVUE-OS Upgrade Guide

Fabric Management and Administration Guides

GigaVUE Administration Guide

covers both GigaVUE-OS and GigaVUE-FM

GigaVUE Fabric Management Guide

how to install, deploy, and operate GigaVUE-FM; how to configure GigaSMART operations; covers both GigaVUE-FM and GigaVUE-OS features

Cloud Guides

how to configure the GigaVUE Cloud Suite components and set up traffic monitoring sessions for the cloud platforms

GigaVUE V Series Quick Start Guide

GigaVUE Cloud Suite for AWS–GigaVUE V Series 2 Guide

GigaVUE Cloud Suite for Azure–GigaVUE V Series 2 Guide

GigaVUE Cloud Suite for OpenStack–GigaVUE V Series 2 Guide

GigaVUE Cloud Suite for VMware—GigaVUE V Series Guide

GigaVUE Cloud Suite for AnyCloud Guide

Universal Container Tap Guide

Gigamon Containerized Broker Guide

GigaVUE Cloud Suite for Kubernetes Guide

GigaVUE Cloud Suite for AWS–GigaVUE V Series 1 Guide

GigaVUE Cloud Suite for OpenStack–GigaVUE V Series 1 Guide

GigaVUE H Series 6.0 Hardware and Software Guides

GigaVUE Cloud Suite for Nutanix Guide

GigaVUE Cloud Suite for VMware—GigaVUE-VM Guide

Reference Guides

GigaVUE-OS CLI Reference Guide

library of GigaVUE-OS CLI (Command Line Interface) commands used to configure and operate GigaVUE H Series and TA Series devices

GigaVUE-OS Cabling Quick Reference Guide

guidelines for the different types of cables used to connect Gigamon devices

GigaVUE-OS Compatibility and Interoperability Matrix

compatibility information and interoperability requirements for Gigamon devices

GigaVUE-FM REST API Reference in GigaVUE-FM User's Guide

samples uses of the GigaVUE-FM Application Program Interfaces (APIs)

Release Notes

GigaVUE-OS, GigaVUE-FM, GigaVUE-VM, G-TAP A Series, and GigaVUE Cloud Suite Release Notes

new features, resolved issues, and known issues in this release ;
important notes regarding installing and upgrading to this release

NOTE: Release Notes are not included in the online documentation.

NOTE: Registered Customers can log in to [My Gigamon](#) to download the Software and Release Notes from the Software & Docs page on to [My Gigamon](#). Refer to [How to Download Software and Release Notes from My Gigamon](#).

In-Product Help

GigaVUE-FM Online Help

how to install, deploy, and operate GigaVUE-FM.

GigaVUE-OS H-VUE Online Help

provides links the online documentation.

How to Download Software and Release Notes from My Gigamon

Registered Customers can download software and corresponding Release Notes documents from the **Software & Release Notes** page on to [My Gigamon](#). Use the My Gigamon Software & Docs page to download:

- Gigamon Software installation and upgrade images,
- Release Notes for Gigamon Software, or
- Older versions of PDFs (pre-v5.7).

To download release-specific software, release notes, or older PDFs:

1. Log in to [My Gigamon](#)
2. Click on the **Software & Release Notes** link.
3. Use the **Product** and **Release** filters to find documentation for the current release. For example, select Product: "GigaVUE-FM" and Release: "5.6," enter "pdf" in the search box, and then click **GO** to view all PDF documentation for GigaVUE-FM 5.6.xx.

NOTE: My Gigamon is available to registered customers only. Newer documentation PDFs, with the exception of release notes, are all available through the publicly available online documentation.

Documentation Feedback

We are continuously improving our documentation to make it more accessible while maintaining accuracy and ease of use. Your feedback helps us to improve. To provide feedback and report issues in our documentation, send an email to:

documentationfeedback@gigamon.com

Please provide the following information in the email to help us identify and resolve the issue. Copy and paste this form into your email, complete it as able, and send. We will respond as soon as possible.

Documentation Feedback Form		
About You	Your Name	
	Your Role	
	Your Company	
For Online Topics	Online doc link	<i>(URL for where the issue is)</i>
	Topic Heading	<i>(if it's a long topic, please provide the heading of the section where the issue is)</i>

For PDF Topics	Document Title	<i>(shown on the cover page or in page header)</i>
	Product Version	<i>(shown on the cover page)</i>
	Document Version	<i>(shown on the cover page)</i>
	Chapter Heading	<i>(shown in footer)</i>
	PDF page #	<i>(shown in footer)</i>
How can we improve?	Describe the issue	<i>Describe the error or issue in the documentation. (If it helps, attach an image to show the issue.)</i>
	How can we improve the content? Be as specific as possible.	
	Any other comments?	

Contact Technical Support

For information about Technical Support: Go to **Settings**  > **Support** > **Contact Support** in GigaVUE-FM.

You can also refer to <https://www.gigamon.com/support-and-services/contact-support> for Technical Support hours and contact information.

Email Technical Support at support@gigamon.com.

Contact Sales

Use the following information to Gigamon channel partner or Gigamon sales representatives.

Telephone: +1.408.831.4025

Sales: inside.sales@gigamon.com

Partners: www.gigamon.com/partners.html

Premium Support

Email Gigamon at inside.sales@gigamon.com for information on purchasing 24x7 Premium Support. Premium Support entitles you to round-the-clock phone support with a dedicated Support Engineer every day of the week.

The Gigamon Community

The **Gigamon Community** is a technical site where Gigamon users, partners, security and network professionals and Gigamon employees come together to share knowledge and expertise, ask questions, build their network and learn about best practices for Gigamon products.

Visit the Gigamon Community site to:

- Find knowledge base articles and documentation
- Ask and answer questions and learn best practices from other members.
- Join special-interest groups to have focused collaboration around a technology, use-case, vertical market or beta release
- Take online learning lessons and tutorials to broaden your knowledge of Gigamon products.
- Submit and vote on feature enhancements and share product feedback. (Customers only)
- Open support tickets (Customers only)
- Download the latest product updates and documentation (Customers only)

The Gigamon Community is a great way to get answers fast, learn from experts and collaborate directly with other members around your areas of interest.

Register today at community.gigamon.com

Questions? Contact our Community team at community@gigamon.com.

Glossary

D

decrypt list

need to decrypt (formerly blacklist)

decryptlist

need to decrypt - CLI Command (formerly blacklist)

drop list

selective forwarding - drop (formerly blacklist)

F

forward list

selective forwarding - forward (formerly whitelist)

L

leader

leader in clustering node relationship (formerly master)

M

member node

follower in clustering node relationship (formerly slave or non-master)

N

no-decrypt list

no need to decrypt (formerly whitelist)

nodecryptlist

no need to decrypt- CLI Command (formerly whitelist)

P

primary source

root timing; transmits sync info to clocks in its network segment (formerly grandmaster)

R

receiver

follower in a bidirectional clock relationship (formerly slave)

S

source

leader in a bidirectional clock relationship (formerly master)